



deal . II user meeting, Heidelberg, 3.-5. Jan. 2006

Discontinuous Galerkin methods in aerodynamics: Higher Order, Error Estimation and Adaptivity

Ralf Hartmann

**Numerical Methods
Institute of Aerodynamics and Flow Technology
German Aerospace Center**

- ▶ structured grid generator: MegaCads
- ▶ structured Finite Volume flow solver: Flower
- ▶ unstructured Finite Volume flow solver: TAU

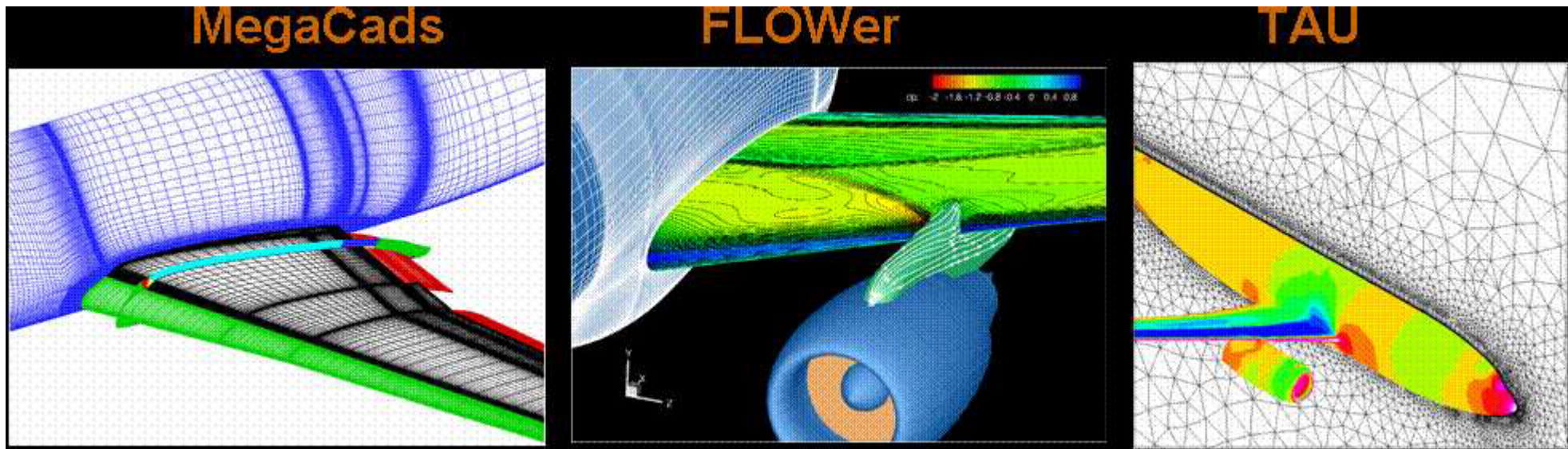

used in industry: Airbus, EADS-M, ...

Higher order methods:

- ▶ Numerical resolution and tracking of vortices
 - Helicopters: Vortex creation and blade-vortex interaction
 - Transport aircrafts: wake-vortices
- ▶ Numerical resolution of viscous boundary layers
- ▶ Numerical approximation of aerodynamical forces: lift, drag, moments



Error estimation:

- ▶ Reliable prediction of aerodynamical forces

Adaptivity:

- ▶ Mesh refinement for better resolution of vortices, boundary layers, etc.
- ▶ Goal-oriented mesh refinement for accurate approximation of aerodynamical forces



- ▶ **The compressible Euler and Navier-Stokes equations**
- ▶ **DG discretization**
- ▶ **Nonlinear solution method**
- ▶ **Higher order computations**
- ▶ **Shock-capturing**
- ▶ **A posteriori error estimation**
- ▶ **Goal-oriented adaptivity**

- ▶ **R. Hartmann and P. Houston**
Symmetric interior penalty DG methods for the compressible Navier-Stokes equations I: Method formulation
Int. J. Numer. Anal. Model. 3(1): 1-20, 2006.
- ▶ **R. Hartmann and P. Houston**
Symmetric interior penalty DG methods for the compressible Navier-Stokes equations II: Goal-oriented a posteriori error estimation
Int. J. Numer. Anal. Model. 3(2): 141-162, 2006.
- ▶ **R. Hartmann**
Adaptive discontinuous Galerkin methods with shock-capturing for the compressible Navier-Stokes equations
Int. J. Numer. Meth. Fluids (2006). To appear.
- ▶ **W. Bangerth, R. Hartmann and G. Kanschat**
deal.II C++ FEM library, <http://www.dealii.org>

The compressible Euler equations:

$$\frac{\partial}{\partial t} \begin{pmatrix} \rho \\ \rho v_1 \\ \rho v_2 \\ \rho E \end{pmatrix} + \frac{\partial}{\partial x_1} \begin{pmatrix} \rho v_1 \\ \rho v_1^2 + p \\ \rho v_1 v_2 \\ v_1(\rho E + p) \end{pmatrix} + \frac{\partial}{\partial x_2} \begin{pmatrix} \rho v_2 \\ \rho v_1 v_2 \\ \rho v_2^2 + p \\ v_2(\rho E + p) \end{pmatrix} = 0$$

The compressible Euler equations:

$$\frac{\partial}{\partial t} \begin{pmatrix} \rho \\ \rho v_1 \\ \rho v_2 \\ \rho E \end{pmatrix} + \frac{\partial}{\partial x_1} \begin{pmatrix} \rho v_1 \\ \rho v_1^2 + p \\ \rho v_1 v_2 \\ v_1(\rho E + p) \end{pmatrix} + \frac{\partial}{\partial x_2} \begin{pmatrix} \rho v_2 \\ \rho v_1 v_2 \\ \rho v_2^2 + p \\ v_2(\rho E + p) \end{pmatrix} = 0$$
$$\frac{\partial}{\partial t} \mathbf{u} + \frac{\partial}{\partial x_1} \mathbf{f}_1^c(\mathbf{u}) + \frac{\partial}{\partial x_2} \mathbf{f}_2^c(\mathbf{u}) = 0$$

The compr. Euler and Navier-Stokes equations in 2D

The compressible Euler equations:

$$\frac{\partial}{\partial t} \begin{pmatrix} \rho \\ \rho v_1 \\ \rho v_2 \\ \rho E \end{pmatrix} + \frac{\partial}{\partial x_1} \begin{pmatrix} \rho v_1 \\ \rho v_1^2 + p \\ \rho v_1 v_2 \\ v_1(\rho E + p) \end{pmatrix} + \frac{\partial}{\partial x_2} \begin{pmatrix} \rho v_2 \\ \rho v_1 v_2 \\ \rho v_2^2 + p \\ v_2(\rho E + p) \end{pmatrix} = 0$$

$$\frac{\partial}{\partial t} \mathbf{u} + \frac{\partial}{\partial x_1} \mathbf{f}_1^c(\mathbf{u}) + \frac{\partial}{\partial x_2} \mathbf{f}_2^c(\mathbf{u}) = 0$$

$$\frac{\partial}{\partial t} \mathbf{u} + \nabla \cdot \mathcal{F}^c(\mathbf{u}) = 0$$

The compr. Euler and Navier-Stokes equations in 2D

The compressible Euler equations:

$$\frac{\partial}{\partial t} \begin{pmatrix} \rho \\ \rho v_1 \\ \rho v_2 \\ \rho E \end{pmatrix} + \frac{\partial}{\partial x_1} \begin{pmatrix} \rho v_1 \\ \rho v_1^2 + p \\ \rho v_1 v_2 \\ v_1(\rho E + p) \end{pmatrix} + \frac{\partial}{\partial x_2} \begin{pmatrix} \rho v_2 \\ \rho v_1 v_2 \\ \rho v_2^2 + p \\ v_2(\rho E + p) \end{pmatrix} = 0$$

$$\frac{\partial}{\partial t} \mathbf{u} + \frac{\partial}{\partial x_1} \mathbf{f}_1^c(\mathbf{u}) + \frac{\partial}{\partial x_2} \mathbf{f}_2^c(\mathbf{u}) = 0$$

$$\frac{\partial}{\partial t} \mathbf{u} + \nabla \cdot \mathcal{F}^c(\mathbf{u}) = 0$$

The compressible Navier-Stokes equations:

$$\frac{\partial}{\partial t} \mathbf{u} + \nabla \cdot \mathcal{F}^c(\mathbf{u}) - \nabla \cdot \mathcal{F}^v(\mathbf{u}, \nabla \mathbf{u}) = 0$$

The compr. Euler and Navier-Stokes equations in 2D

The compressible Euler equations:

$$\frac{\partial}{\partial t} \begin{pmatrix} \rho \\ \rho v_1 \\ \rho v_2 \\ \rho E \end{pmatrix} + \frac{\partial}{\partial x_1} \begin{pmatrix} \rho v_1 \\ \rho v_1^2 + p \\ \rho v_1 v_2 \\ v_1(\rho E + p) \end{pmatrix} + \frac{\partial}{\partial x_2} \begin{pmatrix} \rho v_2 \\ \rho v_1 v_2 \\ \rho v_2^2 + p \\ v_2(\rho E + p) \end{pmatrix} = 0$$

$$\frac{\partial}{\partial t} \mathbf{u} + \frac{\partial}{\partial x_1} \mathbf{f}_1^c(\mathbf{u}) + \frac{\partial}{\partial x_2} \mathbf{f}_2^c(\mathbf{u}) = 0$$

$$\frac{\partial}{\partial t} \mathbf{u} + \nabla \cdot \mathcal{F}^c(\mathbf{u}) = 0$$

The compressible Navier-Stokes equations:

$$\frac{\partial}{\partial t} \mathbf{u} + \nabla \cdot \mathcal{F}^c(\mathbf{u}) - \nabla \cdot \mathcal{F}^v(\mathbf{u}, \nabla \mathbf{u}) = 0$$

$$\mathbf{f}_1^v(\mathbf{u}, \nabla \mathbf{u}) = \begin{pmatrix} 0 \\ \tau_{11} \\ \tau_{21} \\ \tau_{11}v_1 + \tau_{12}v_2 + \kappa T_{x_1} \end{pmatrix}, \quad \mathbf{f}_2^v(\mathbf{u}, \nabla \mathbf{u}) = \begin{pmatrix} 0 \\ \tau_{12} \\ \tau_{22} \\ \tau_{21}v_1 + \tau_{22}v_2 + \kappa T_{x_2} \end{pmatrix}.$$

The problem:

$$\nabla \cdot \mathcal{F}^c(\mathbf{u}) = 0 \quad \text{in } \Omega,$$

with $\mathbf{u} = (\rho, \rho v_1, \rho v_2, \rho E)^T$.

The discretization of **DG(p)**: Find \mathbf{u}_h in \mathbf{V}_h^p such that

$$\begin{aligned} \mathcal{N}(\mathbf{u}_h, \mathbf{v}_h) \equiv & \sum_{\kappa \in \mathcal{T}_h} \left\{ - \int_{\kappa} \mathcal{F}^c(\mathbf{u}_h) : \nabla \mathbf{v}_h \, dx + \int_{\partial\kappa \setminus \Gamma} \mathcal{H}(\mathbf{u}_h^+, \mathbf{u}_h^-, \mathbf{n}_\kappa) \mathbf{v}_h^+ \, ds \right\} \\ & + \int_{\Gamma} \mathcal{H}(\mathbf{u}_h^+, \mathbf{u}_\Gamma(\mathbf{u}_h^+), \mathbf{n}_\kappa) \mathbf{v}_h^+ \, ds = 0 \quad \forall \mathbf{v}_h \in \mathbf{V}_h^p, \end{aligned}$$

with

$$\mathbf{V}_h^p = \left\{ \mathbf{v} \in [L_2(\Omega)]^4 : \mathbf{v}|_\kappa \in [\mathcal{Q}_p(\kappa)]^4 \quad \forall \kappa \in \mathcal{T}_h \right\},$$

DG discretization of the compr. Euler equations

The problem:

$$\nabla \cdot \mathcal{F}^c(\mathbf{u}) = 0 \quad \text{in } \Omega,$$

with $\mathbf{u} = (\rho, \rho v_1, \rho v_2, \rho E)^T$.

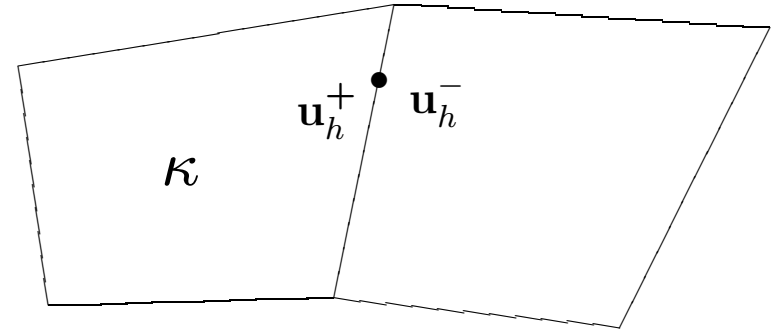

The discretization of DG(p): Find \mathbf{u}_h in \mathbf{V}_h^p such that

$$\begin{aligned} \mathcal{N}(\mathbf{u}_h, \mathbf{v}_h) \equiv & \sum_{\kappa \in \mathcal{T}_h} \left\{ - \int_{\kappa} \mathcal{F}^c(\mathbf{u}_h) : \nabla \mathbf{v}_h \, dx + \int_{\partial\kappa \setminus \Gamma} \mathcal{H}(\mathbf{u}_h^+, \mathbf{u}_h^-, \mathbf{n}_{\kappa}) \mathbf{v}_h^+ \, ds \right\} \\ & + \int_{\Gamma} \mathcal{H}(\mathbf{u}_h^+, \mathbf{u}_{\Gamma}(\mathbf{u}_h^+), \mathbf{n}_{\kappa}) \mathbf{v}_h^+ \, ds = 0 \quad \forall \mathbf{v}_h \in \mathbf{V}_h^p, \end{aligned}$$

with

$$\mathbf{V}_h^p = \left\{ \mathbf{v} \in [L_2(\Omega)]^4 : \mathbf{v}|_{\kappa} \in [\mathcal{Q}_p(\kappa)]^4 \quad \forall \kappa \in \mathcal{T}_h \right\},$$

DG discretization of the compr. Euler equations

The problem:

$$\nabla \cdot \mathcal{F}^c(\mathbf{u}) = 0 \quad \text{in } \Omega,$$

with $\mathbf{u} = (\varrho, \varrho v_1, \varrho v_2, \rho E)^T$.

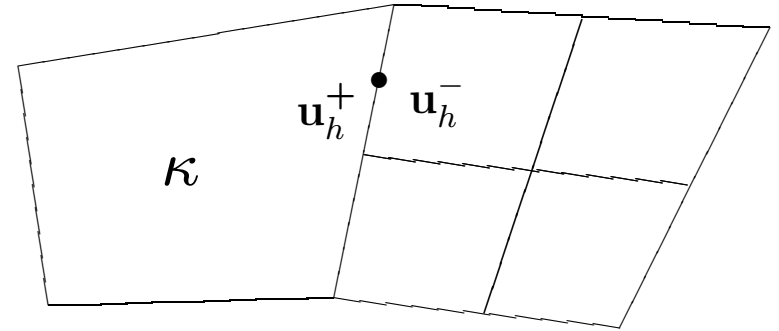

The discretization of DG(p): Find \mathbf{u}_h in \mathbf{V}_h^p such that

$$\begin{aligned} \mathcal{N}(\mathbf{u}_h, \mathbf{v}_h) \equiv & \sum_{\kappa \in \mathcal{T}_h} \left\{ - \int_{\kappa} \mathcal{F}^c(\mathbf{u}_h) : \nabla \mathbf{v}_h \, dx + \int_{\partial\kappa \setminus \Gamma} \mathcal{H}(\mathbf{u}_h^+, \mathbf{u}_h^-, \mathbf{n}_\kappa) \mathbf{v}_h^+ \, ds \right\} \\ & + \int_{\Gamma} \mathcal{H}(\mathbf{u}_h^+, \mathbf{u}_\Gamma(\mathbf{u}_h^+), \mathbf{n}_\kappa) \mathbf{v}_h^+ \, ds = 0 \quad \forall \mathbf{v}_h \in \mathbf{V}_h^p, \end{aligned}$$

with

$$\mathbf{V}_h^p = \left\{ \mathbf{v} \in [L_2(\Omega)]^4 : \mathbf{v}|_\kappa \in [\mathcal{Q}_p(\kappa)]^4 \quad \forall \kappa \in \mathcal{T}_h \right\},$$

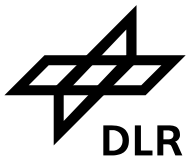

DG discretization of the compr. Navier-Stokes equations

Find \mathbf{u}_h in V_h^p such that

$$\begin{aligned}
 \mathcal{N}(\mathbf{u}_h, \mathbf{v}_h) \equiv & - \int_{\Omega} \mathcal{F}^c(\mathbf{u}_h) : \nabla_h \mathbf{v}_h \, dx + \sum_{\kappa \in \mathcal{T}_h} \int_{\partial\kappa \setminus \Gamma} \mathcal{H}(\mathbf{u}_h^+, \mathbf{u}_h^-, \mathbf{n}_\kappa) \cdot \mathbf{v}_h^+ \, ds \\
 & + \int_{\Omega} \mathcal{F}^v(\mathbf{u}_h, \nabla_h \mathbf{u}_h) : \nabla_h \mathbf{v}_h \, dx - \int_{\Gamma_I} \{ \mathcal{F}^v(\mathbf{u}_h, \nabla_h \mathbf{u}_h) \} : \llbracket \mathbf{v}_h \rrbracket \, ds \\
 & - \int_{\Gamma_I} \{ (G_{i1}^T \partial_h \mathbf{v}_h / \partial x_i, G_{i2}^T \partial_h \mathbf{v}_h / \partial x_i) \} : \llbracket \mathbf{u}_h \rrbracket \, ds + \int_{\Gamma_I} \delta \llbracket \mathbf{u}_h \rrbracket : \llbracket \mathbf{v}_h \rrbracket \, ds \\
 & + \int_{\Gamma} \mathcal{H}(\mathbf{u}_h^+, \mathbf{u}_\Gamma(\mathbf{u}_h^+), \mathbf{n}) \cdot \mathbf{v}_h^+ \, ds + \int_{\Gamma \setminus \Gamma_N} \delta (\mathbf{u}_h^+ - \mathbf{u}_\Gamma(\mathbf{u}_h^+)) \cdot \mathbf{v}_h^+ \, ds, \\
 & - \int_{\Gamma \setminus (\Gamma_N \cup \Gamma_{W,adia})} \mathcal{F}^v(\mathbf{u}_h^+, \nabla_h \mathbf{u}_h^+) : \llbracket \mathbf{v}_h \rrbracket \, ds - \int_{\Gamma_N} \mathbf{g}_N \cdot \mathbf{v}_h \, ds \\
 & - \int_{\Gamma_{W,adia}} \mathcal{F}^{v,adia}(\mathbf{u}_h^+, \nabla_h \mathbf{u}_h^+) : \llbracket \mathbf{v}_h \rrbracket \, ds \\
 & - \int_{\Gamma \setminus \Gamma_N} \left(G_{i1}^T(\mathbf{u}_h^+) \partial_h \mathbf{v}_h^+ / \partial x_i, G_{i2}^T(\mathbf{u}_h^+) \partial_h \mathbf{v}_h^+ / \partial x_i \right) : \left(\mathbf{u}_h^+ - \mathbf{u}_\Gamma(\mathbf{u}_h^+) \right) \otimes \mathbf{n} \, ds = 0
 \end{aligned}$$

for all \mathbf{v}_h in V_h^p .

DG discretisation: Find \mathbf{u}_h in V_h^p such that

$$\mathcal{N}(\mathbf{u}_h, \mathbf{v}_h) = 0 \quad \forall \mathbf{v}_h \in V_h^p.$$

Newton iteration: Given \mathbf{u}_h^n , find \mathbf{d}_h^n in V_h^p such that

$$\mathcal{N}'[\mathbf{u}_h^n](\mathbf{d}_h^n, \mathbf{v}_h) = \mathcal{R}(\mathbf{u}_h^n, \mathbf{v}_h) \equiv -\mathcal{N}(\mathbf{u}_h^n, \mathbf{v}_h), \quad \forall \mathbf{v}_h \in V_h^p,$$

and compute update

$$\mathbf{u}_h^{n+1} = \mathbf{u}_h^n + \omega^n \mathbf{d}_h^n.$$

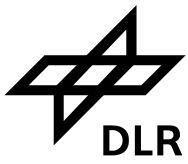

DLR

Laminar test case

$M = 0.5$, $Re = 5000$, $\alpha = 0$ flow around the NACA0012 airfoil

Laminar test case

$M = 0.5$, $Re = 5000$, $\alpha = 0$ flow around the NACA0012 airfoil

Grid of 3072 cells:

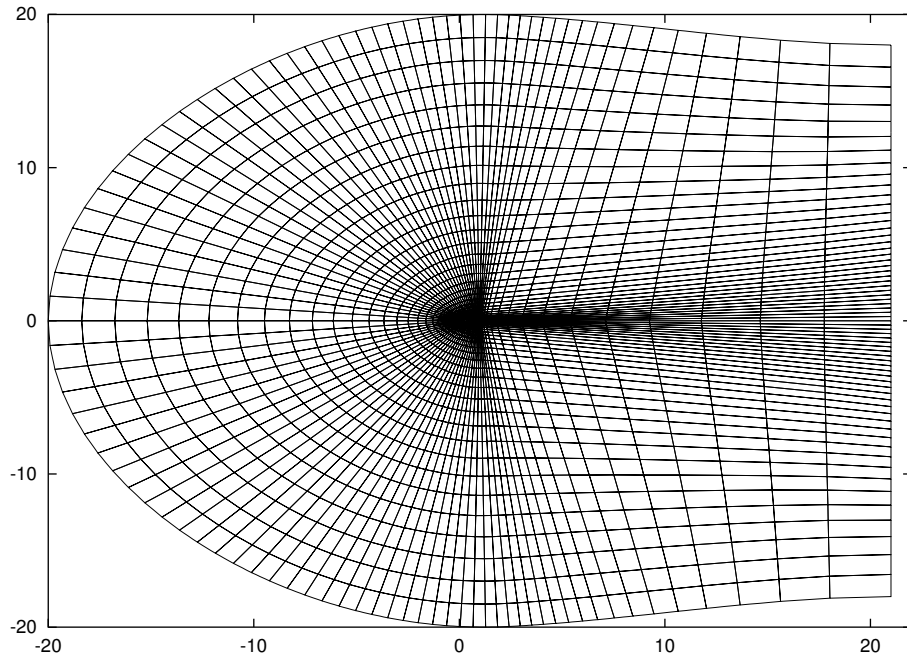

Zoom of this grid:

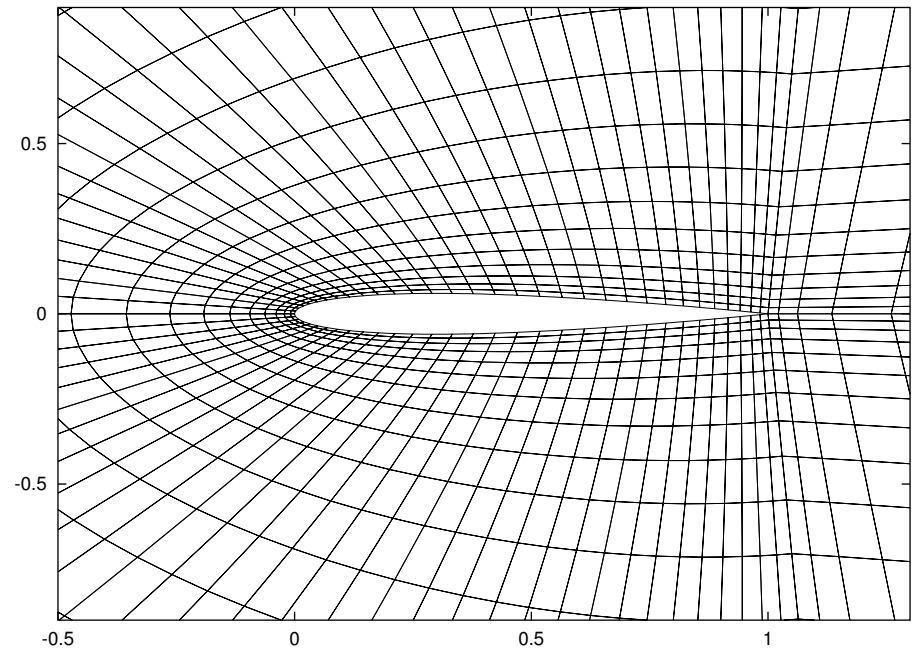

$M = 0.5$, $Re = 5000$, $\alpha = 0$ flow around the NACA0012 airfoil

Grid of 3072 cells:

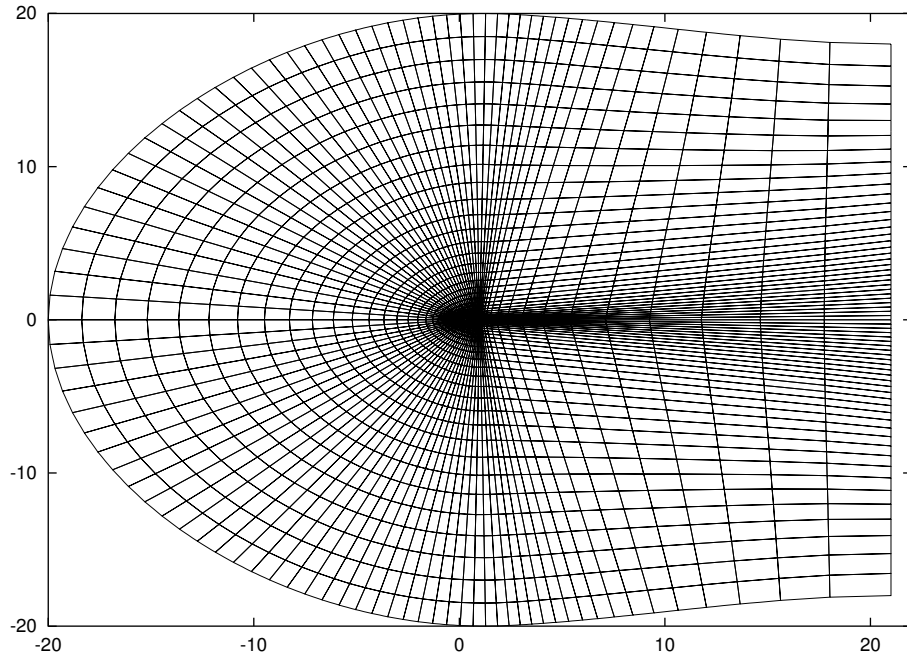

Zoom of this grid:

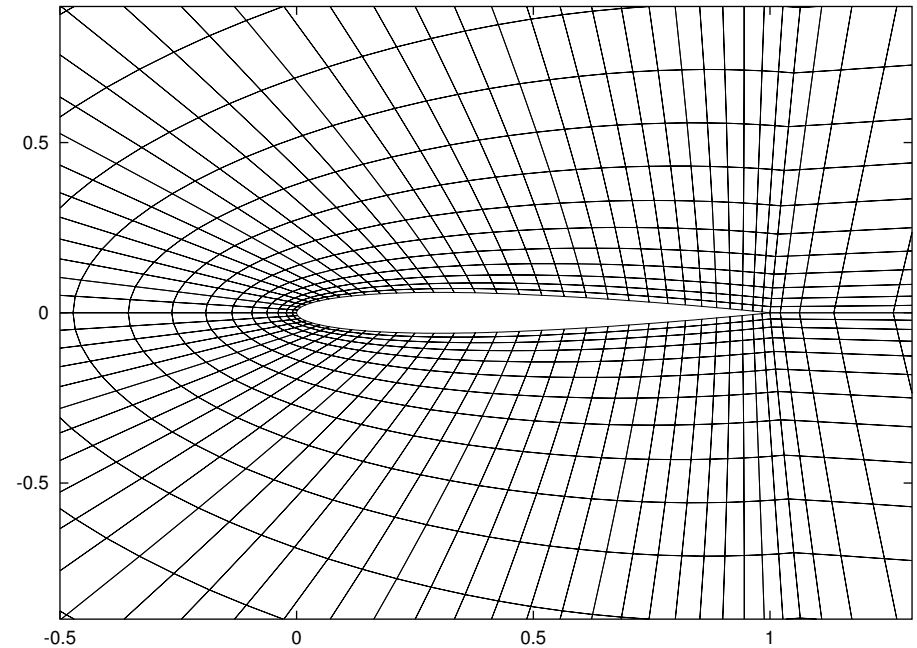

Computation using $DG(p)$, $p = 1, 2, 3$ on sequence of globally refined grids of 3072, 12288, 49152 and 196608 cells



Fully implicit solver: Newton iteration

Each Newton step is solved using GMRES and an ILU preconditioner

Fully implicit solver: Newton iteration

Each Newton step is solved using GMRES and an ILU preconditioner

$M = 0.5$, $Re = 5000$, $\alpha = 0$ flow around NACA0012

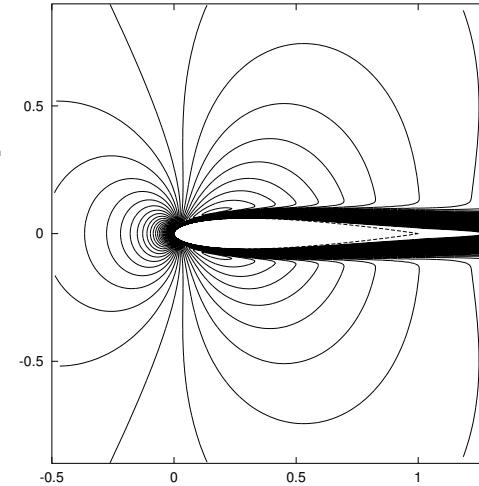

Fully implicit solver: Newton iteration

Each Newton step is solved using GMRES and an ILU preconditioner

$M = 0.5$, $Re = 5000$, $\alpha = 0$ flow around NACA0012

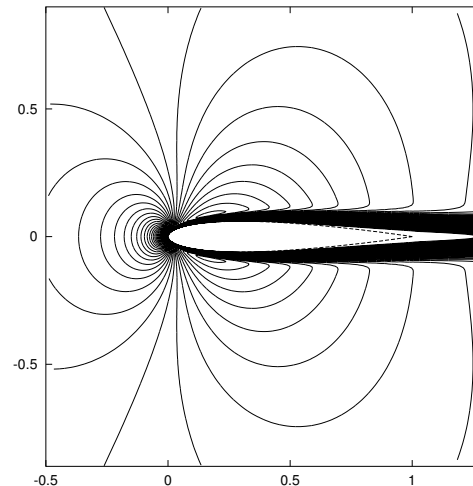

non-linear residuals (DG(1), global refinement)

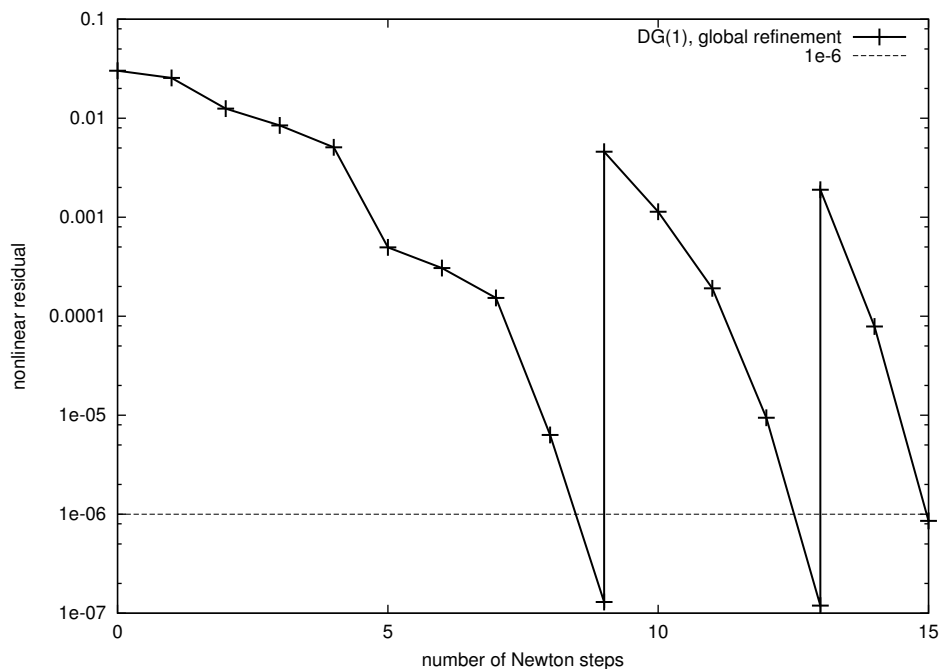

Fully implicit solver: Newton iteration

Each Newton step is solved using GMRES and an ILU preconditioner

$M = 0.5, Re = 5000, \alpha = 0$ flow around NACA0012

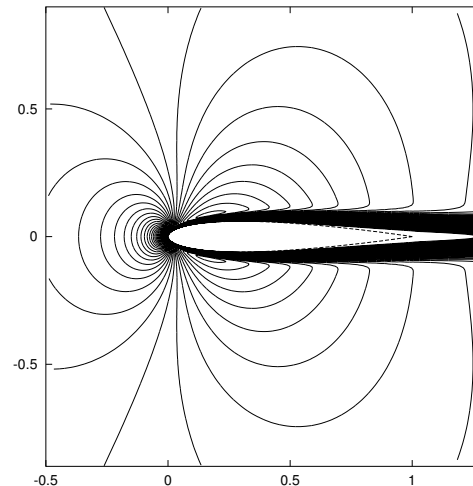

non-linear residuals (DG(1), global refinement)

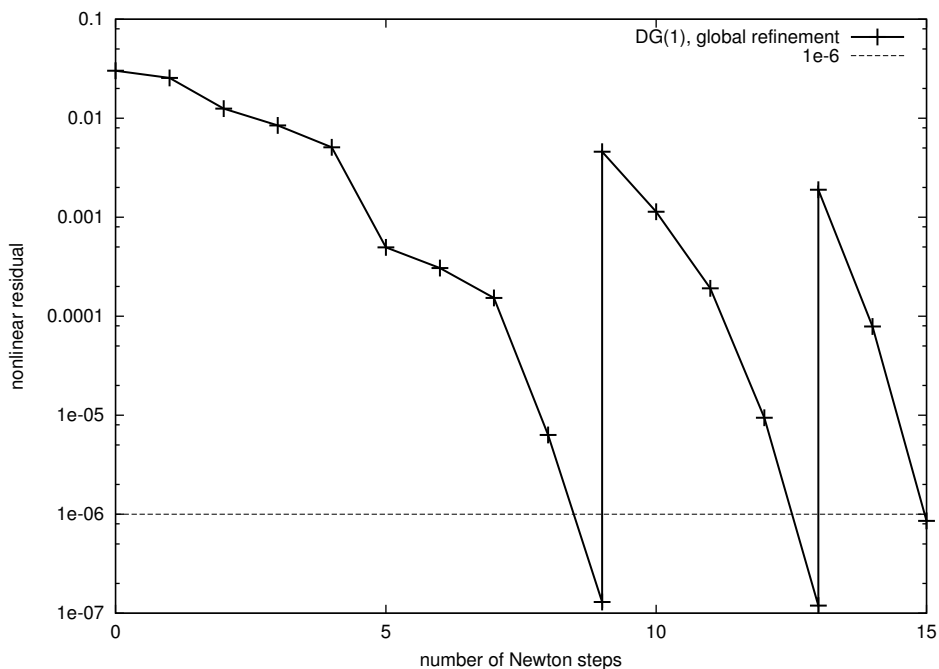

mesh	DG(1)	DG(2)	DG(3)
1	9	4*	4*
2	4	2	2
3	2	2	

* : on a DG(1) pre-iterated solution



Higher order computations for laminar test case

$M = 0.5$, $Re = 5000$, $\alpha = 0$ flow around the NACA0012 airfoil

Convergence of c_{dp} and c_{df} under global refinement

c_{dp} (pressure induced drag)

Higher order computations for laminar test case

$M = 0.5$, $Re = 5000$, $\alpha = 0$ flow around the NACA0012 airfoil

Convergence of cdp and cdf under global refinement

cdp (pressure induced drag)

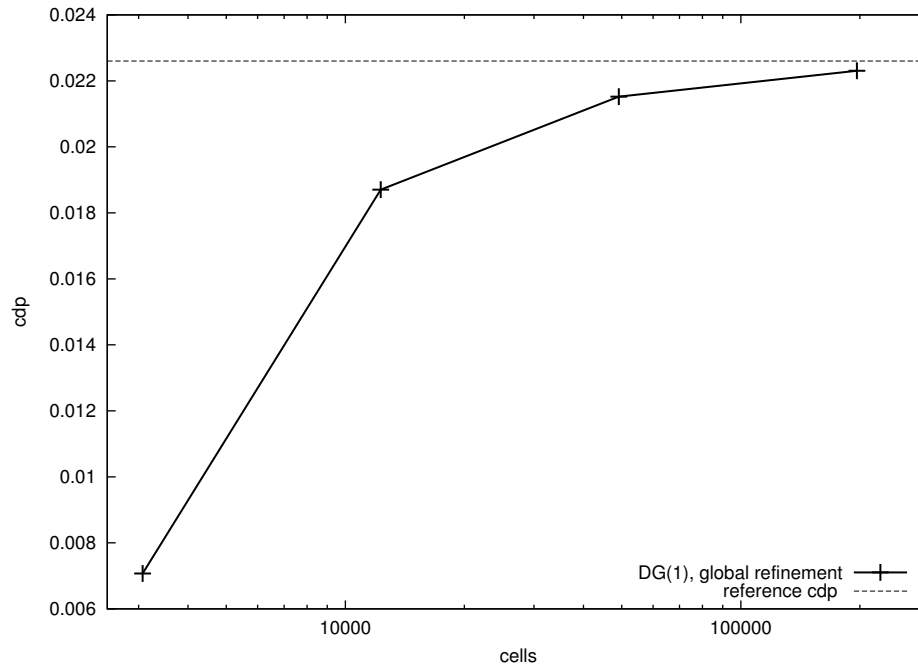

Higher order computations for laminar test case

$M = 0.5, Re = 5000, \alpha = 0$ flow around the NACA0012 airfoil

Convergence of cdp and cdf under global refinement

cdp (pressure induced drag)

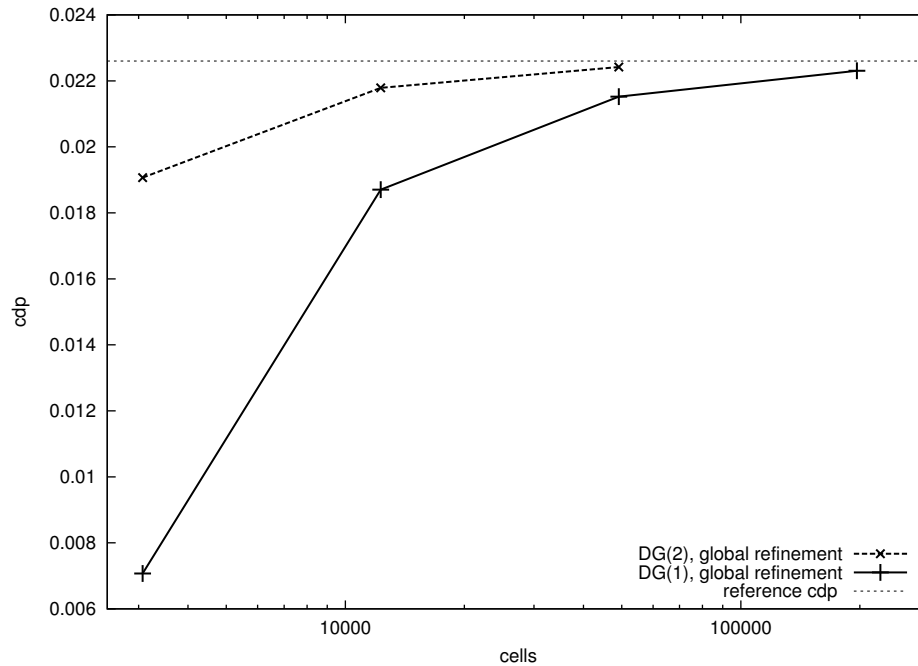

Higher order computations for laminar test case

$M = 0.5, Re = 5000, \alpha = 0$ flow around the NACA0012 airfoil

Convergence of cdp and cdf under global refinement

cdp (pressure induced drag)

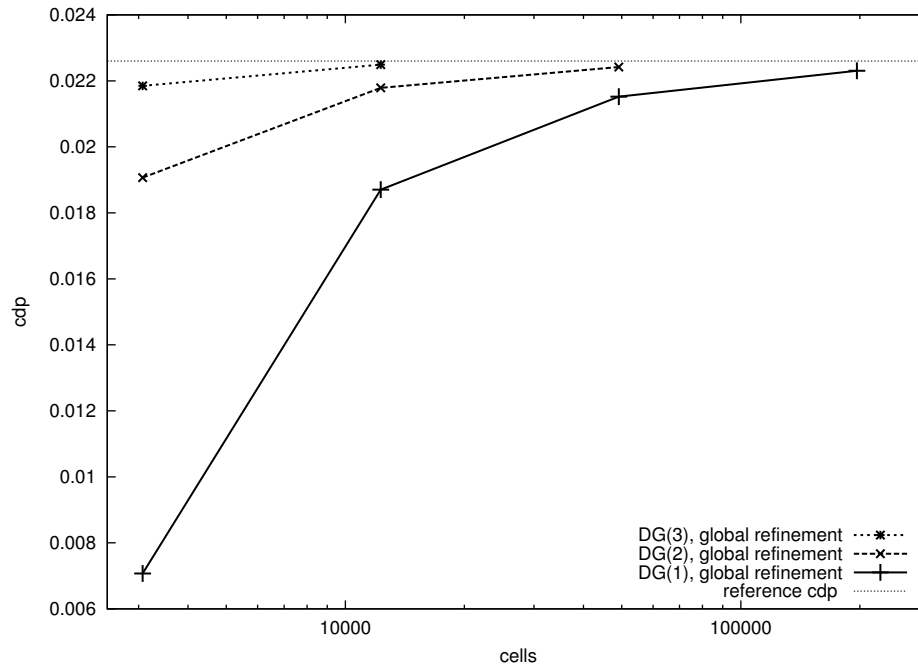

Higher order computations for laminar test case

$M = 0.5, Re = 5000, \alpha = 0$ flow around the NACA0012 airfoil

Convergence of cdp and cdf under global refinement

cdp (pressure induced drag)

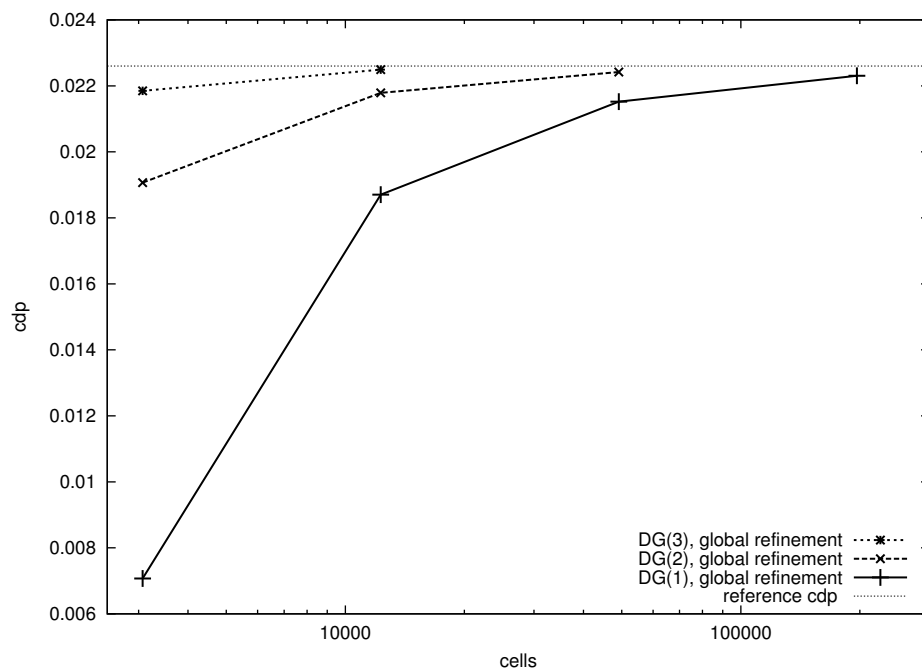

cdf (viscous drag)

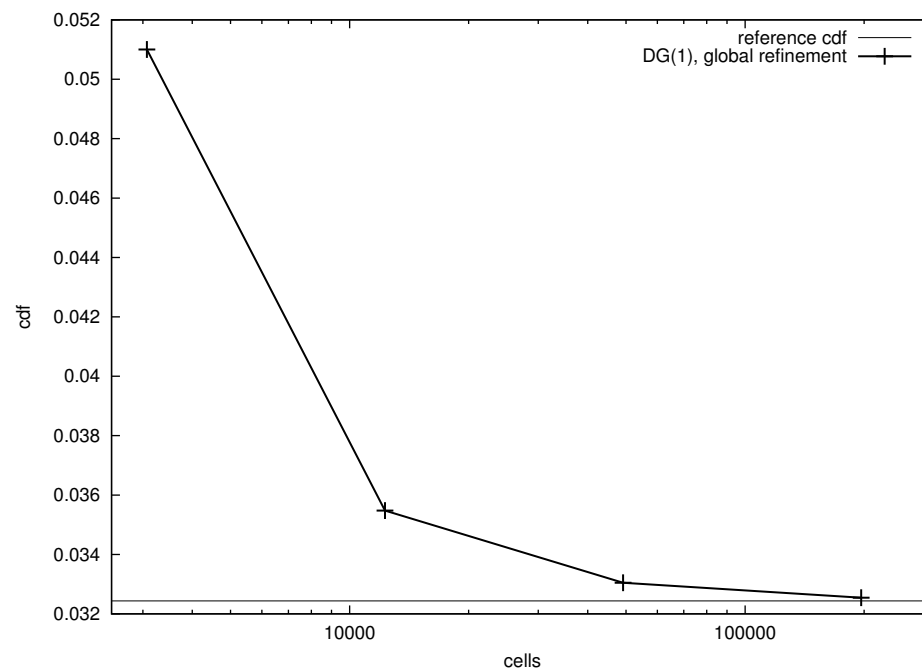

Higher order computations for laminar test case

$M = 0.5, Re = 5000, \alpha = 0$ flow around the NACA0012 airfoil

Convergence of cdp and cdf under global refinement

cdp (pressure induced drag)

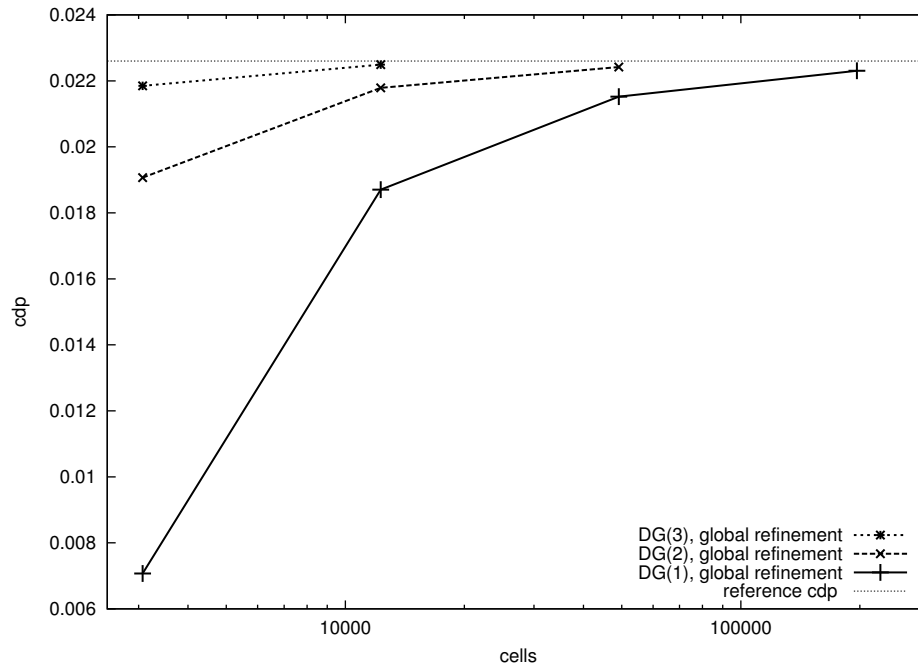

cdf (viscous drag)

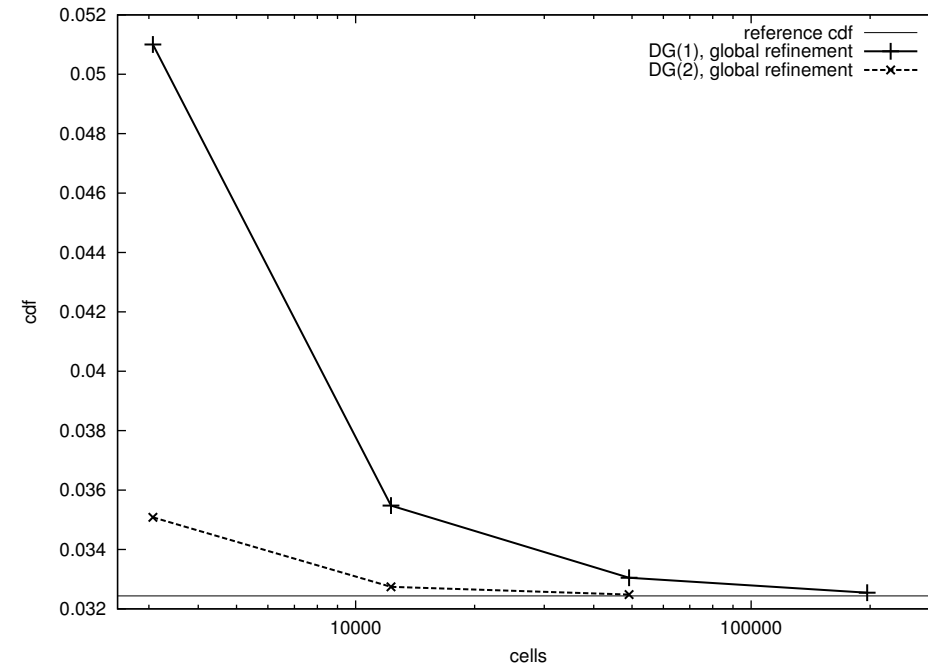

Higher order computations for laminar test case

$M = 0.5, Re = 5000, \alpha = 0$ flow around the NACA0012 airfoil

Convergence of cdp and cdf under global refinement

cdp (pressure induced drag)

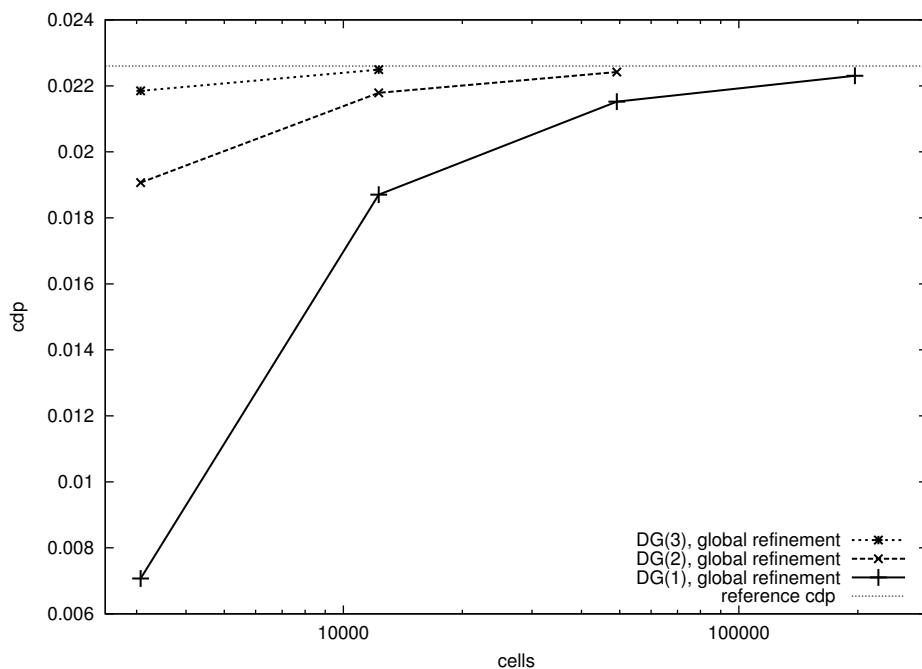

cdf (viscous drag)

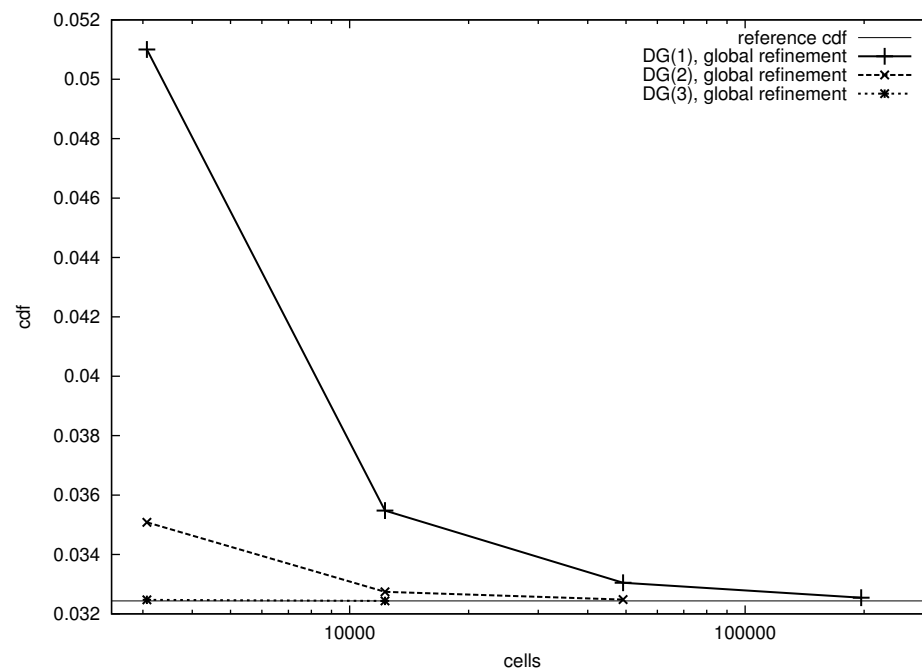

Convergence of cdp

cdp

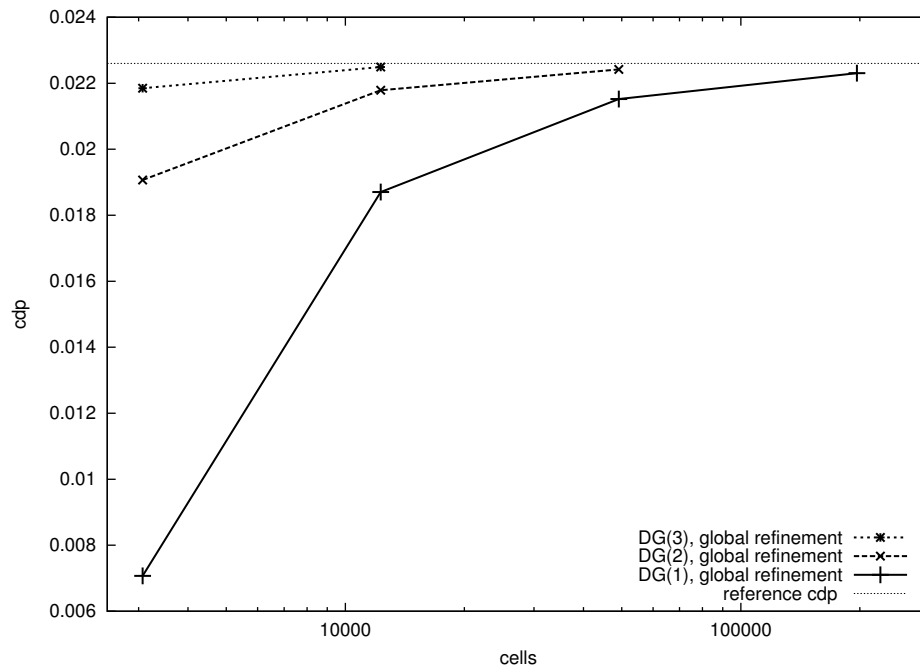

Convergence of cdp

cdp

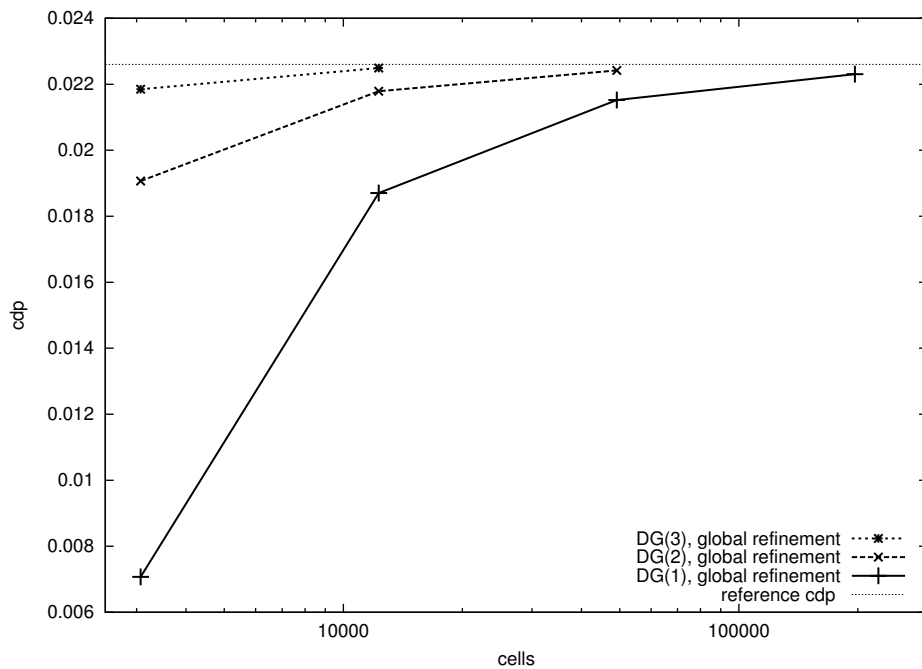

reference cdp - cdp

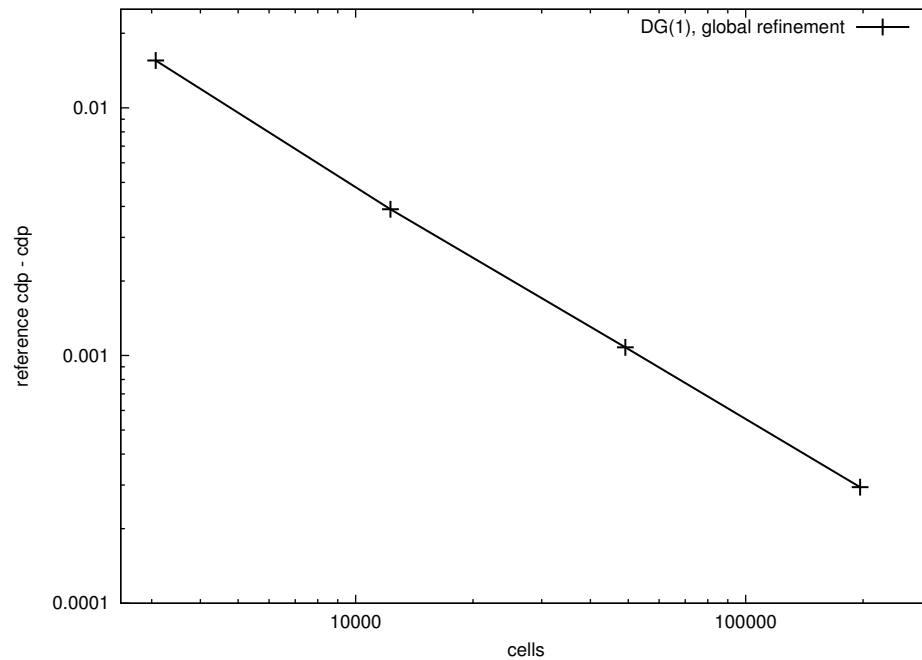

Convergence of cdp

cdp

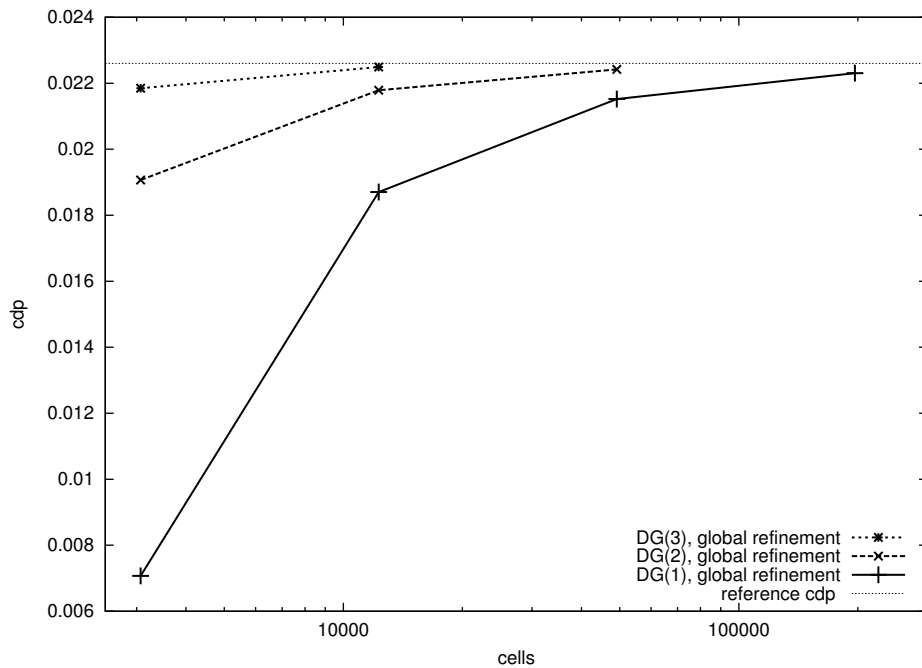

reference cdp - cdp

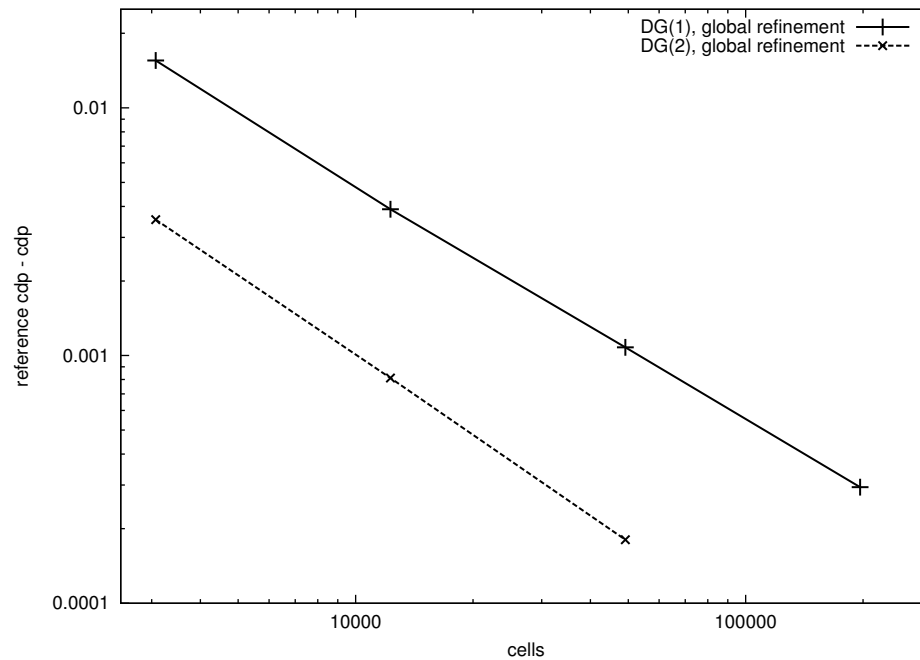

Convergence of cdp

cdp

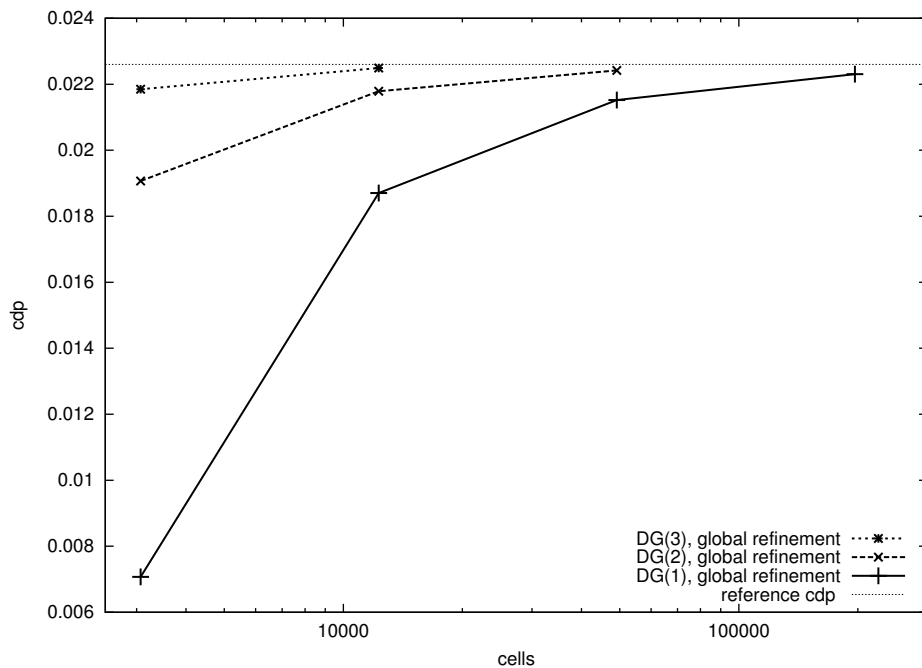

reference cdp - cdp

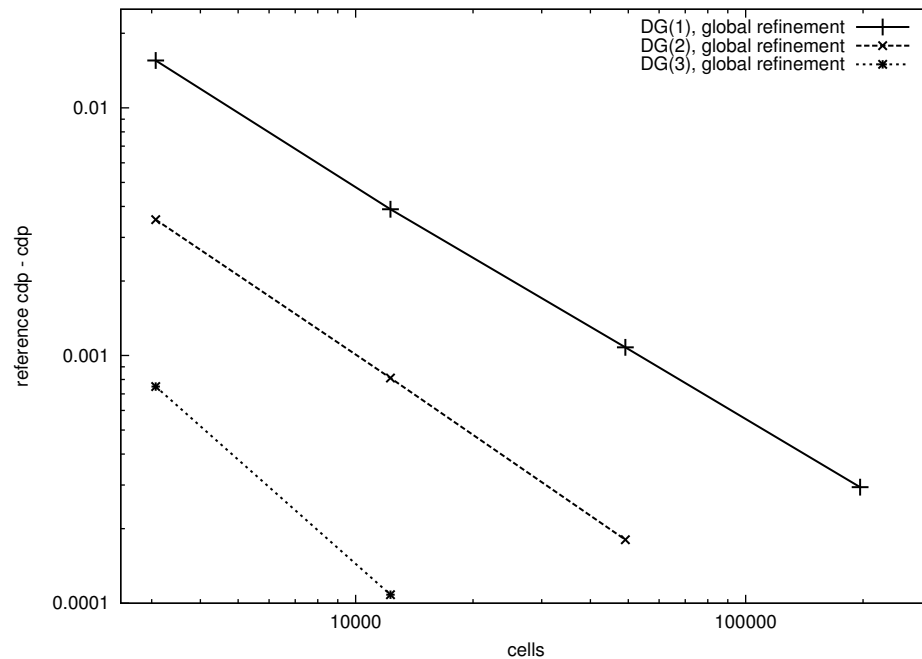

Convergence of cdp

cdp

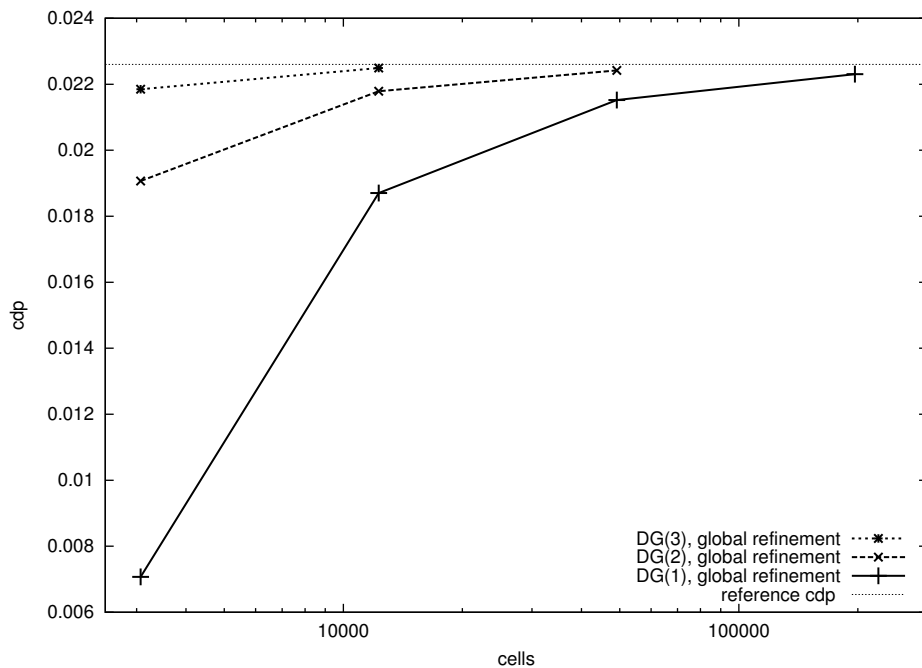

reference cdp - cdp

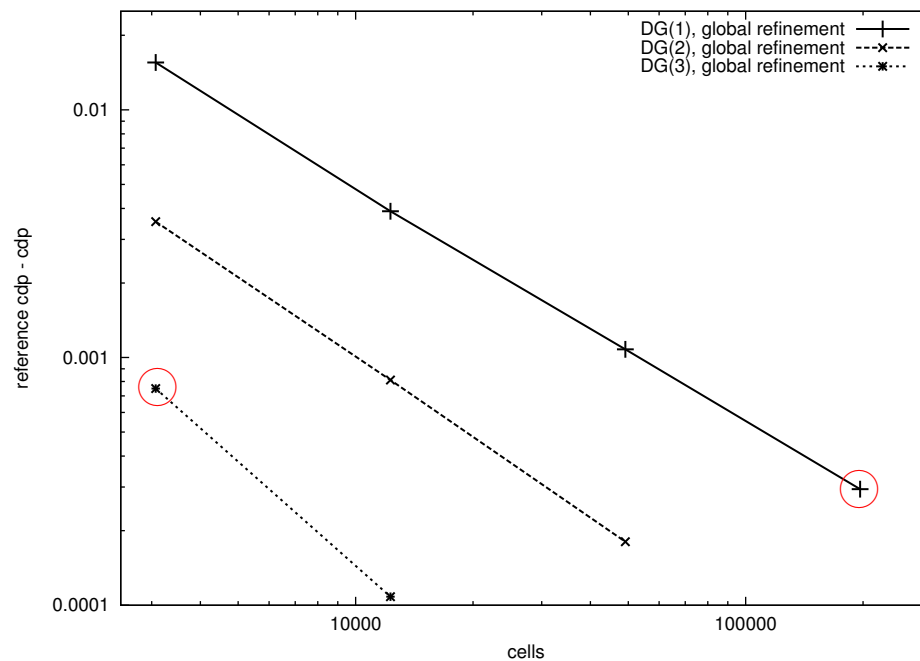

Higher order computations for laminar test case

Convergence of cdp

cdp

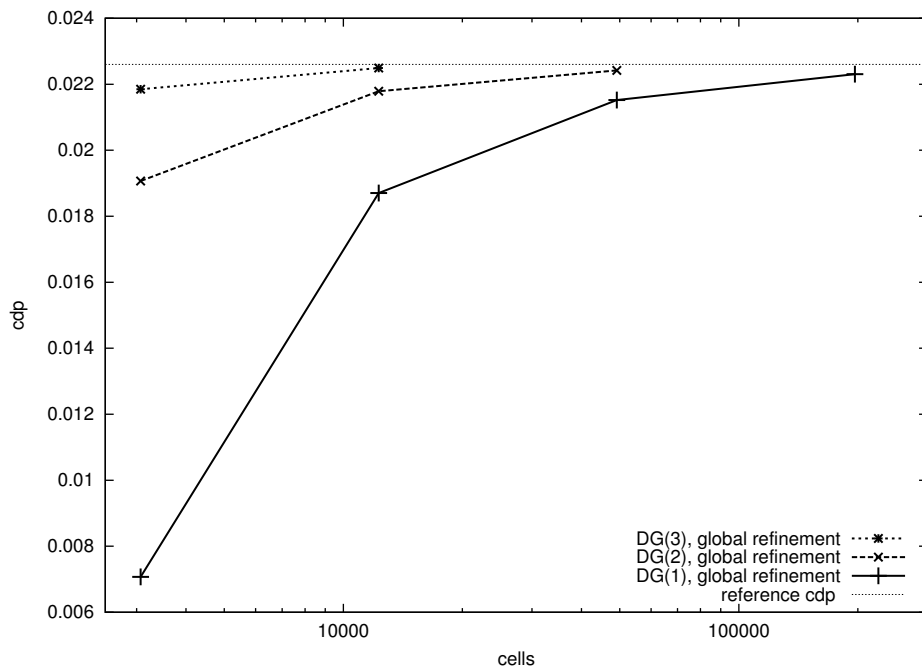

reference cdp - cdp

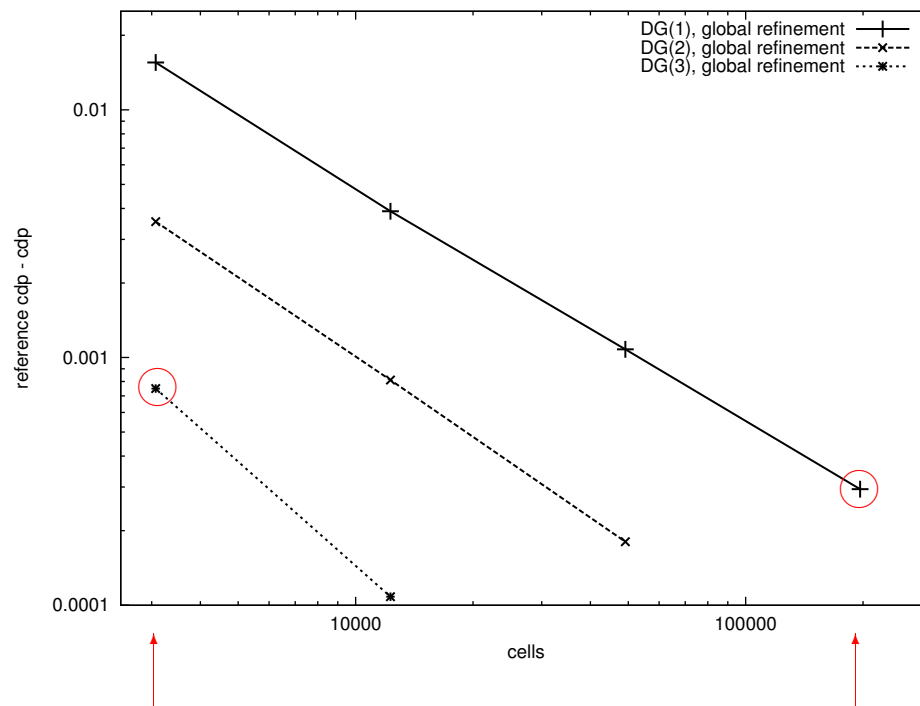

Convergence of cdp

cdp

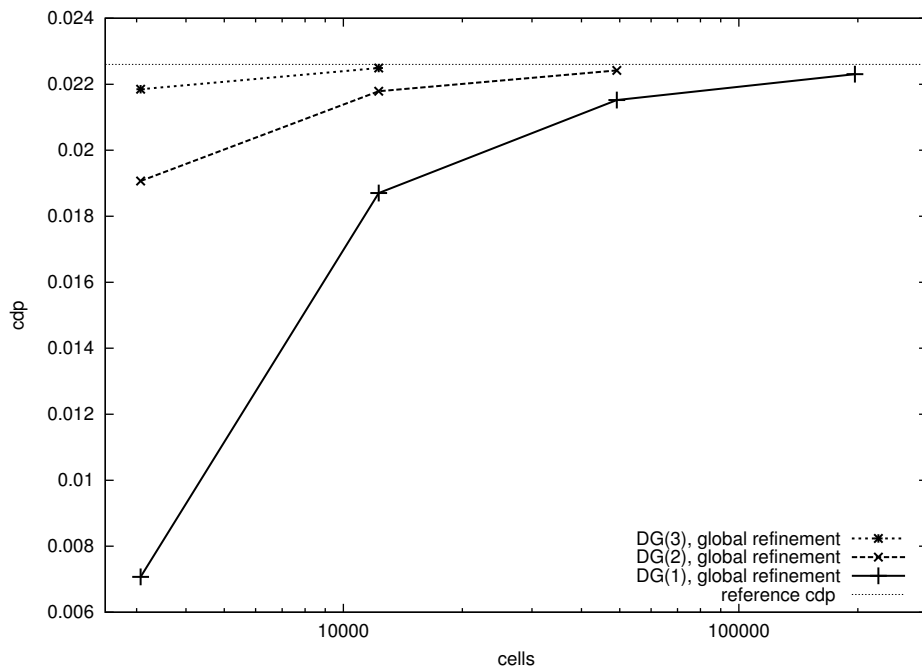

reference cdp - cdp

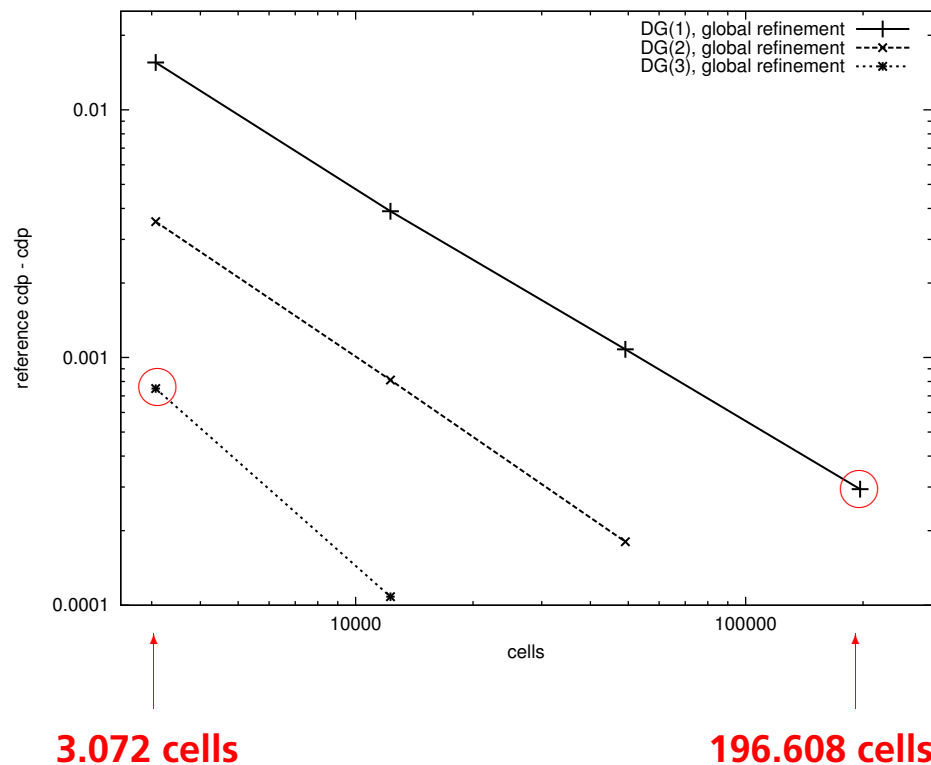

Higher order computations for laminar test case

Convergence of cdp

cdp

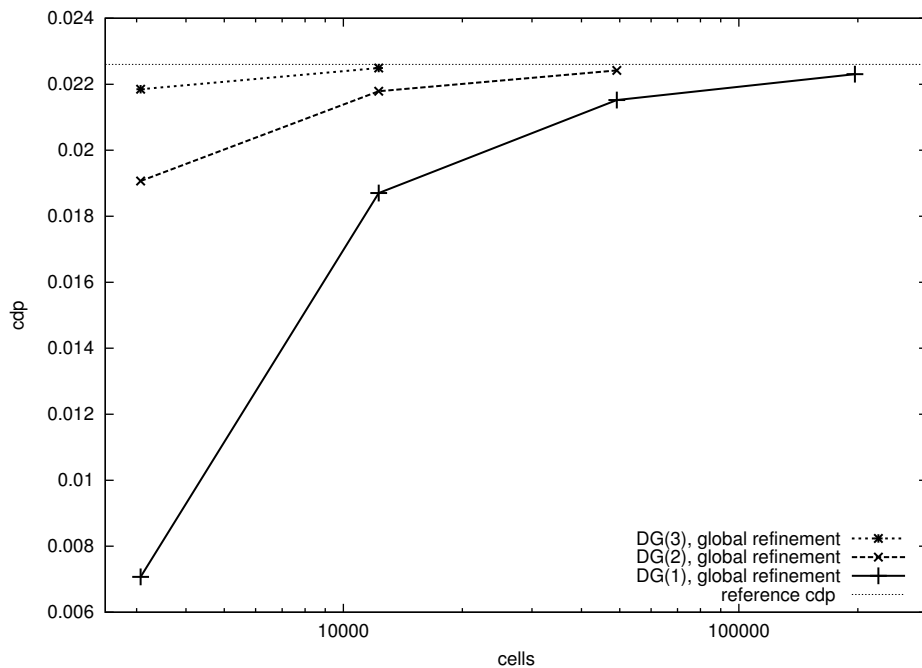

reference cdp - cdp

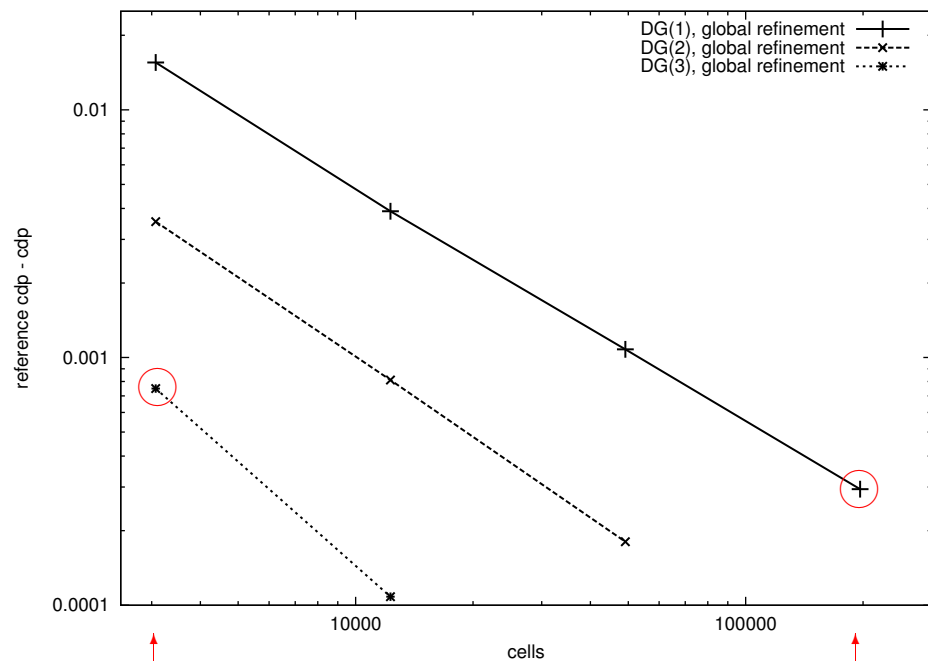

3.072 cells
196.608 dof

196.608 cells
3.145.728 dof

Higher order computations for laminar test case

Convergence of cdp

cdp

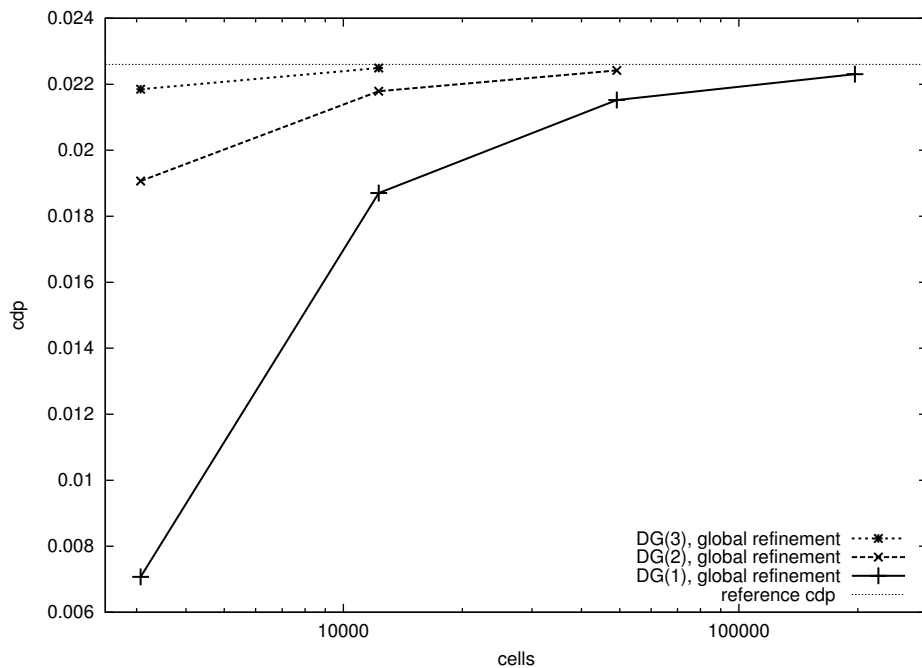

reference cdp - cdp

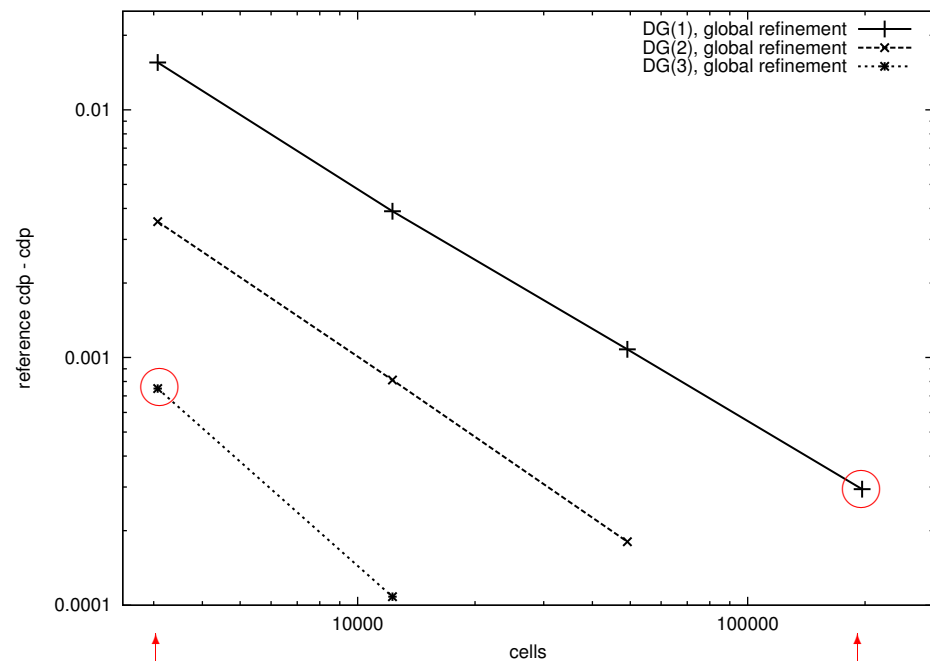

3.072 cells
196.608 dof
8 min

196.608 cells
3.145.728 dof
136 min

Convergence of cdf

cdf

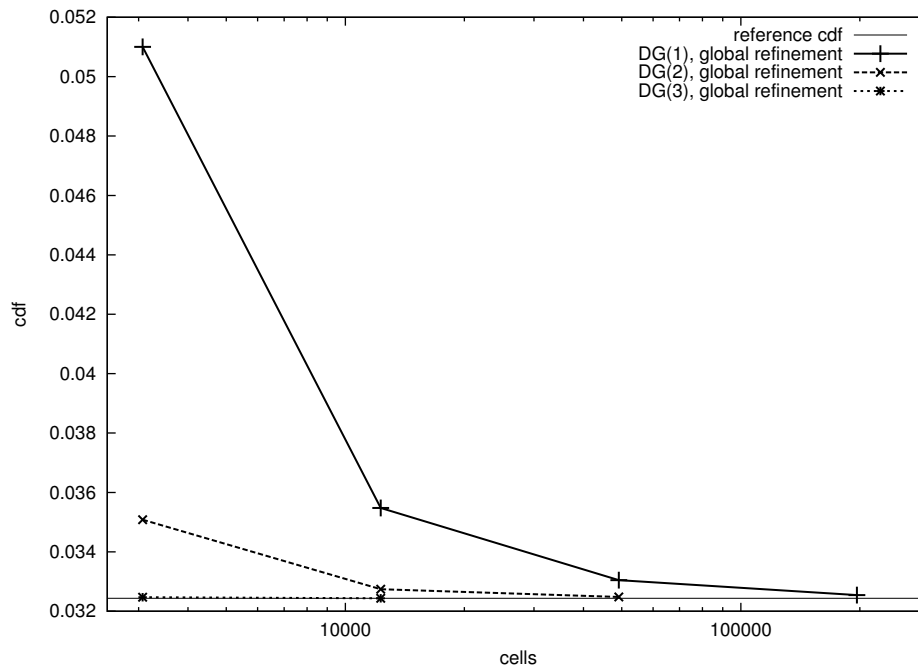

Convergence of cdf

cdf

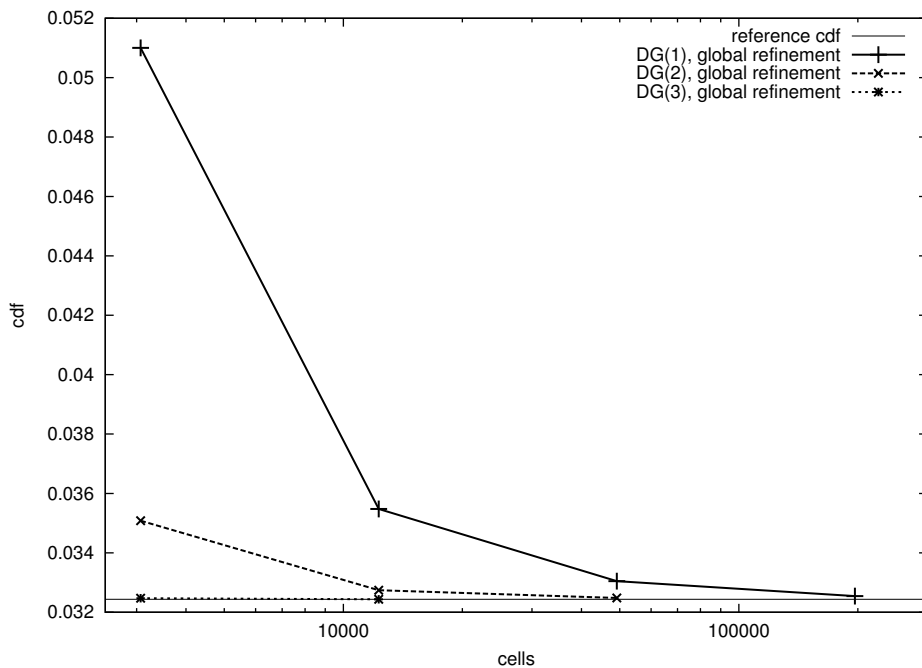

cdf - reference cdf

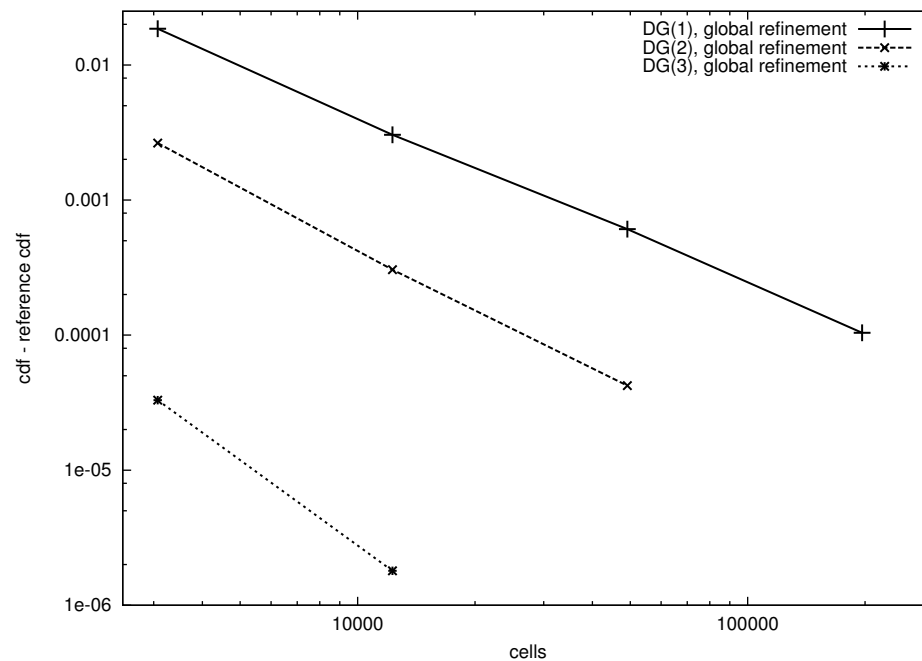

Convergence of cdf

cdf

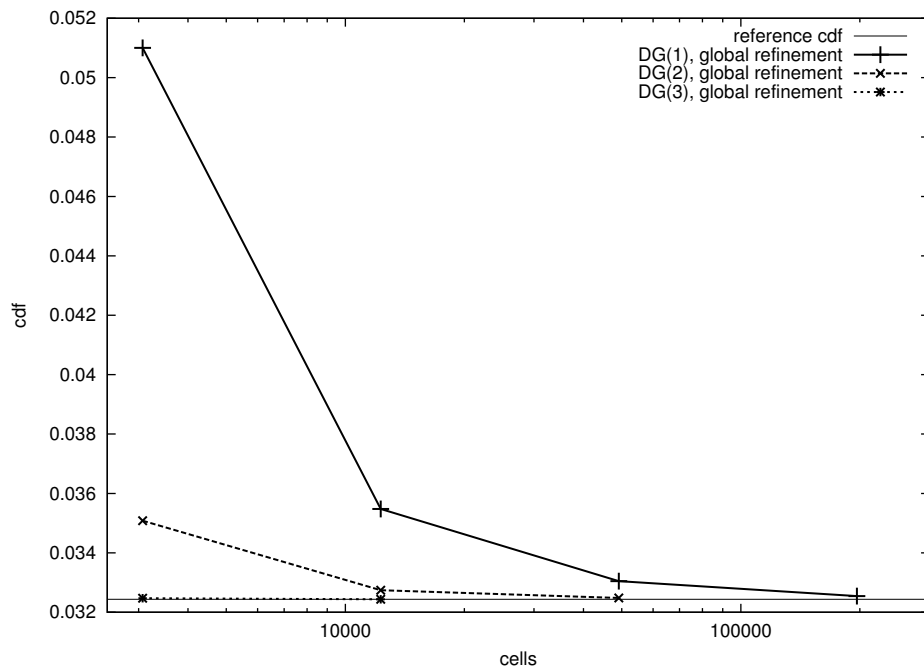

cdf - reference cdf

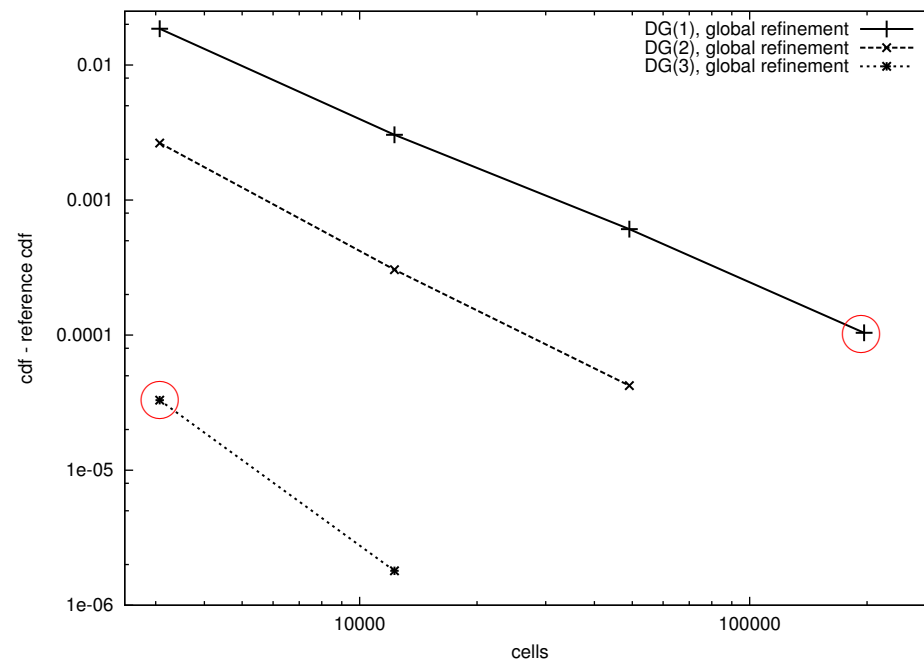

Convergence of cdf

cdf

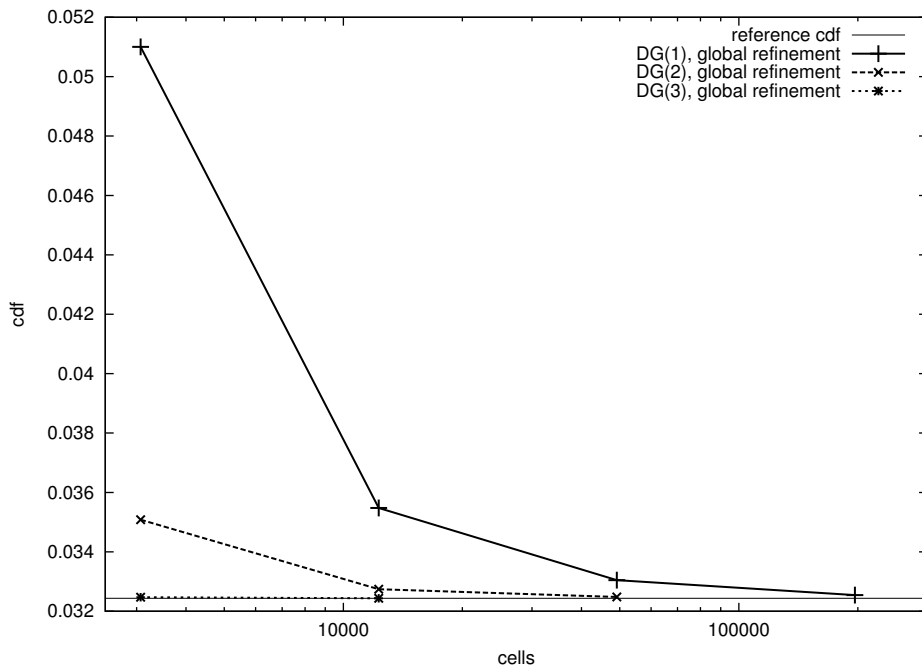

cdf - reference cdf

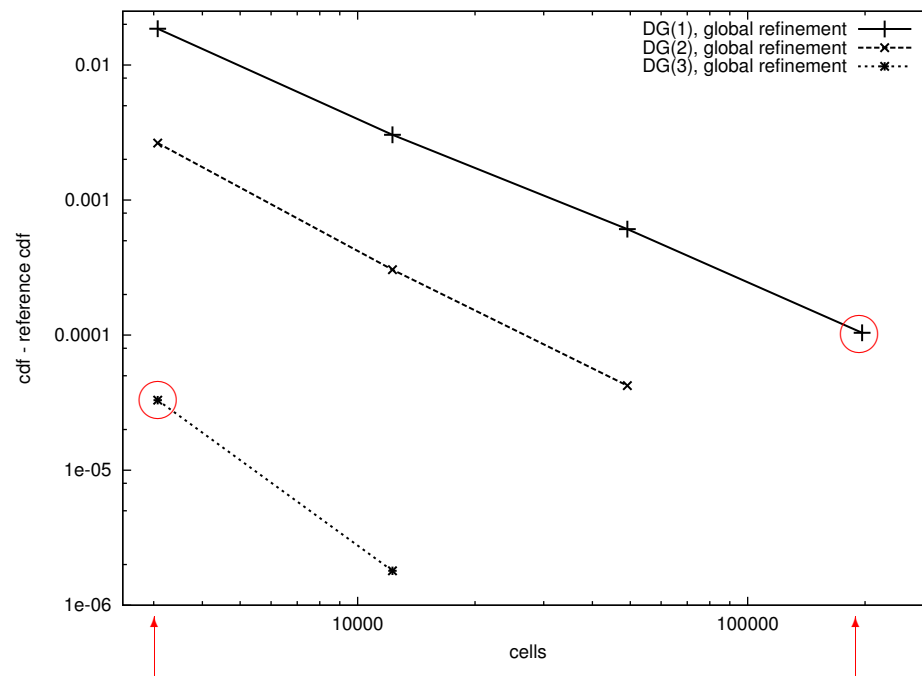

Convergence of cdf

cdf

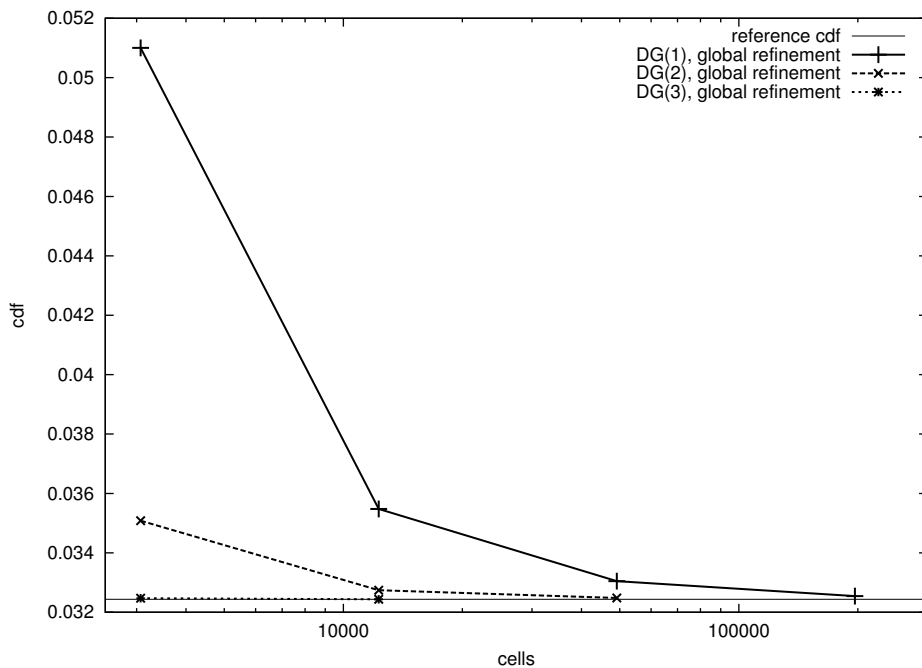

cdf - reference cdf

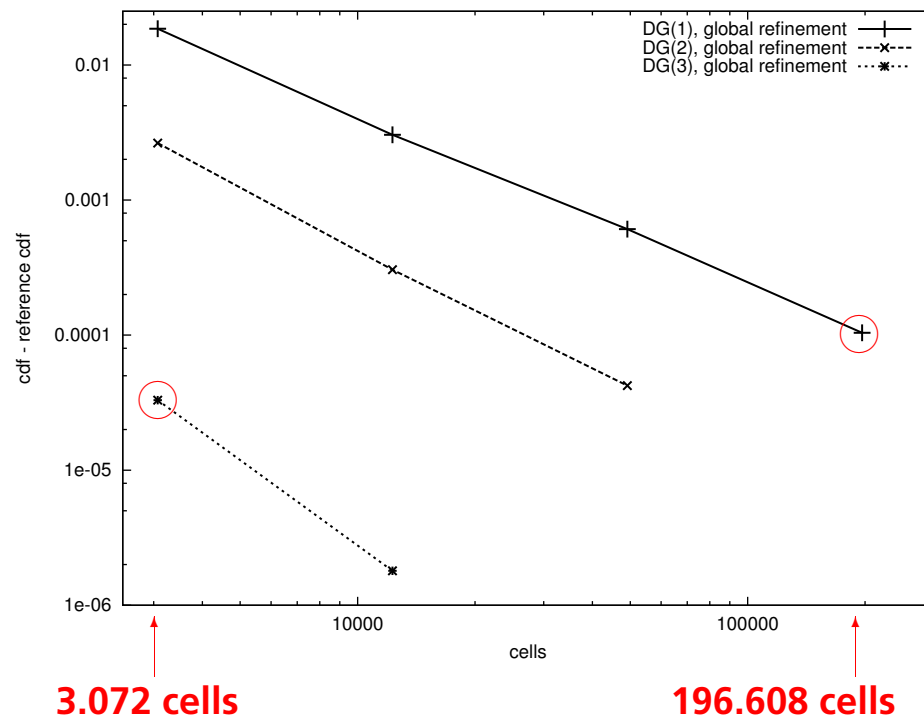

Convergence of cdf

cdf

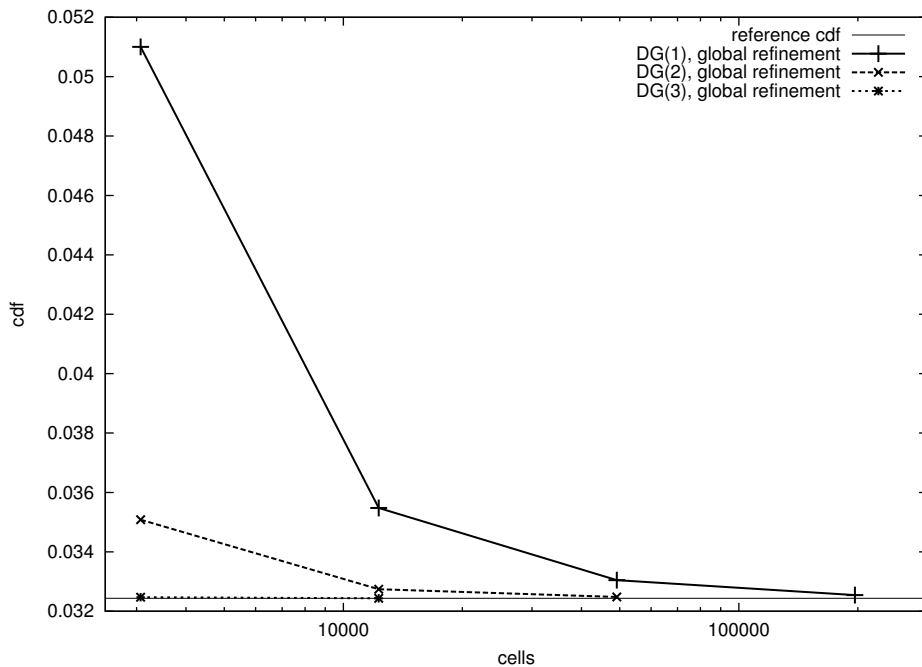

cdf - reference cdf

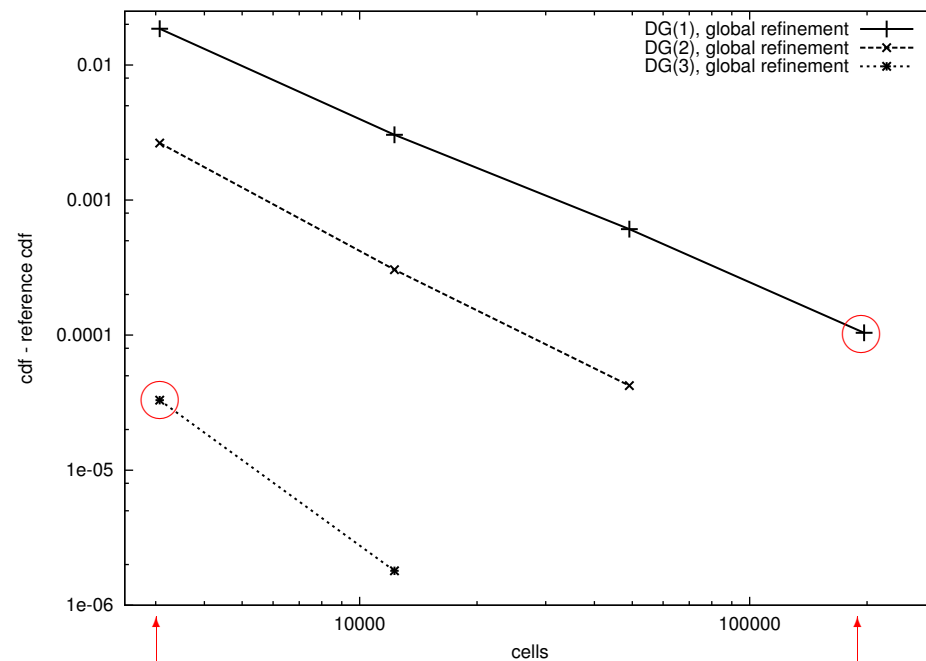

3.072 cells
196.608 dof

196.608 cells
3.145.728 dof

Convergence of cdf

cdf

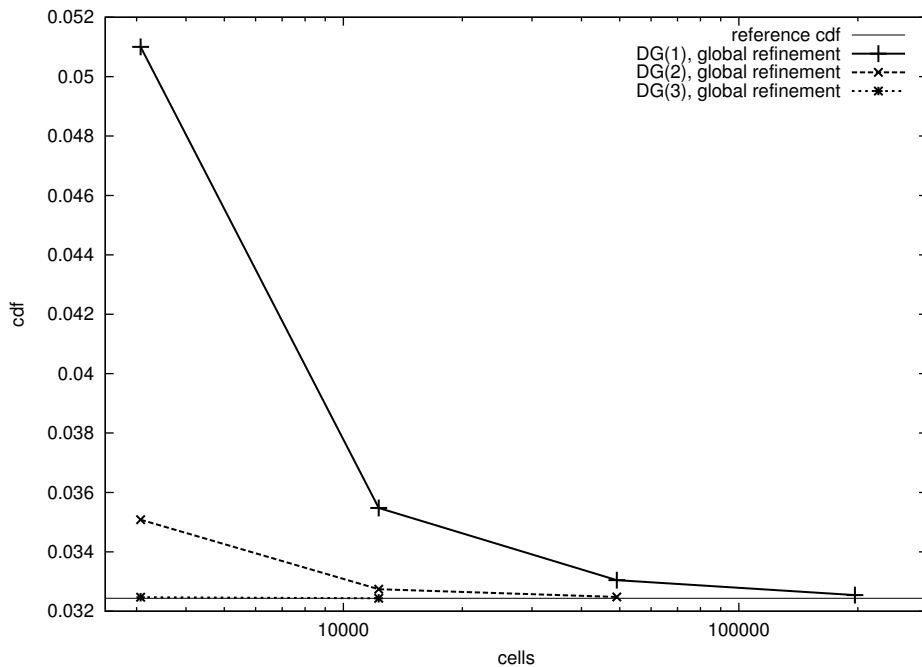

cdf - reference cdf

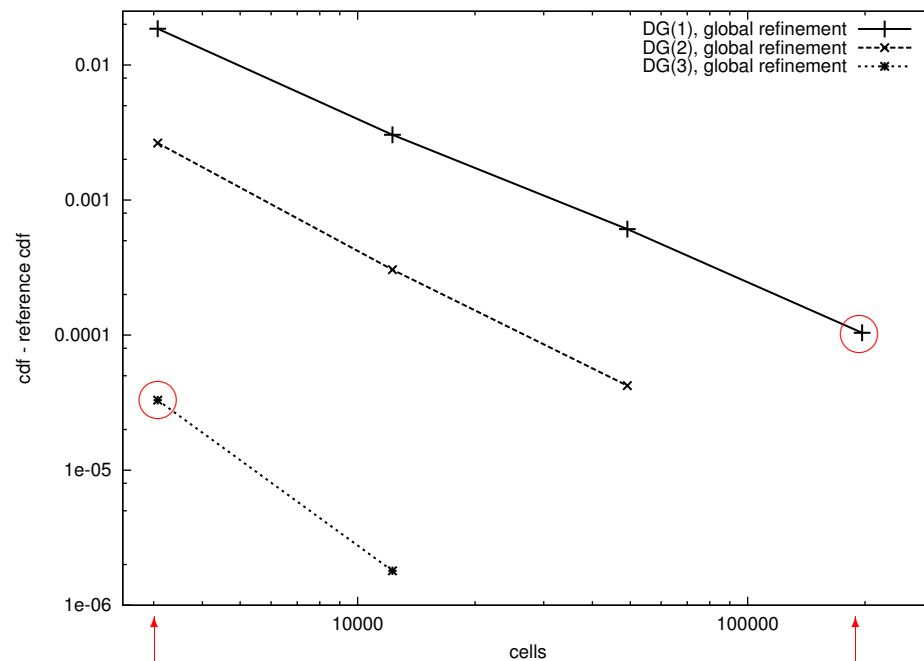

3.072 cells
196.608 dof
8 min

196.608 cells
3.145.728 dof
136 min

Higher order computations for laminar test case

Convergence of cdf

cdf

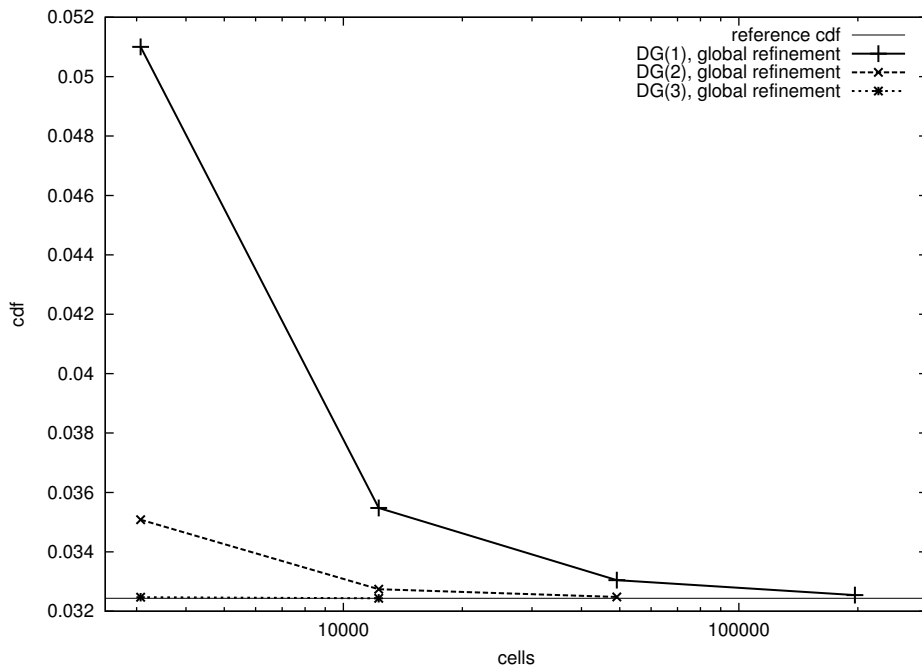

cdf - reference cdf

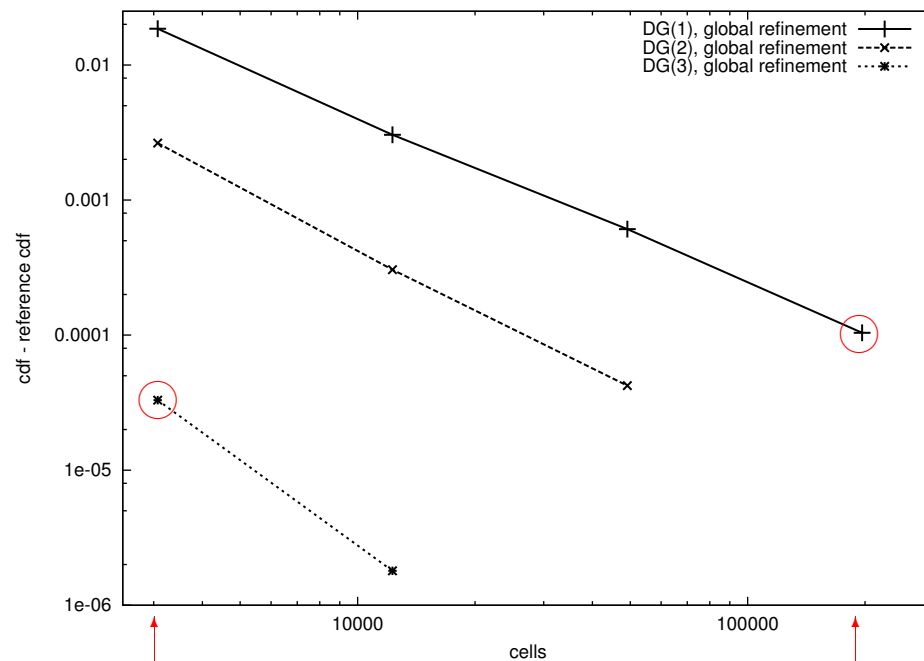

3.072 cells
196.608 dof
8 min

196.608 cells
3.145.728 dof
136 min

786.432 cells
12.582.912 dofs
≈ 12 h (extrapolated)



Higher order approximation of viscous boundary layers

Higher order approximation of viscous boundary layers

Flat plate problem: $M = 0.01, Re = 10000$

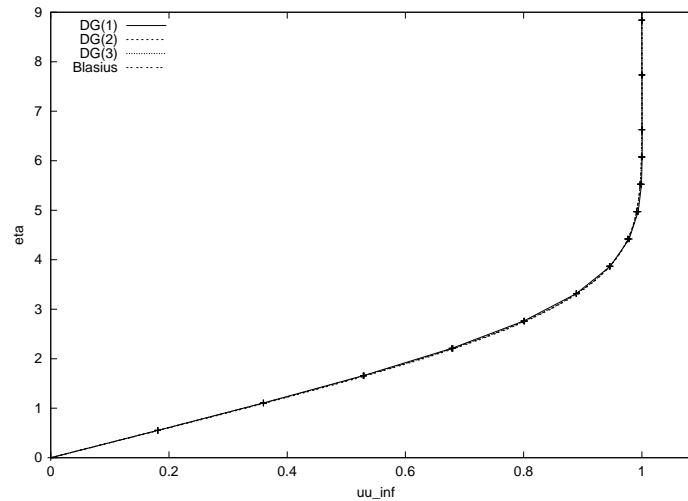
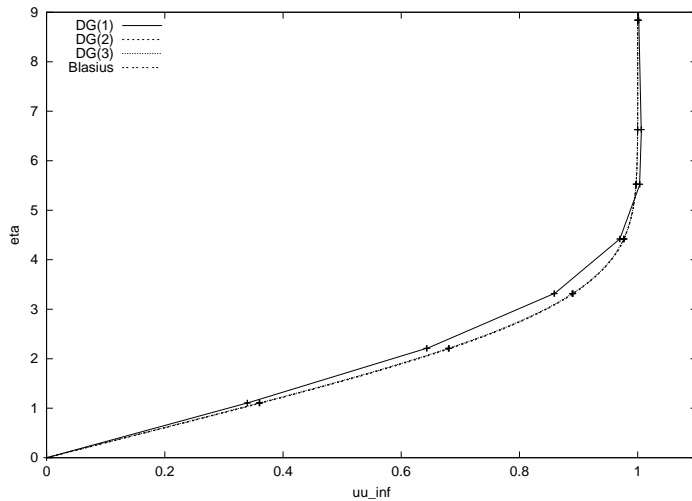
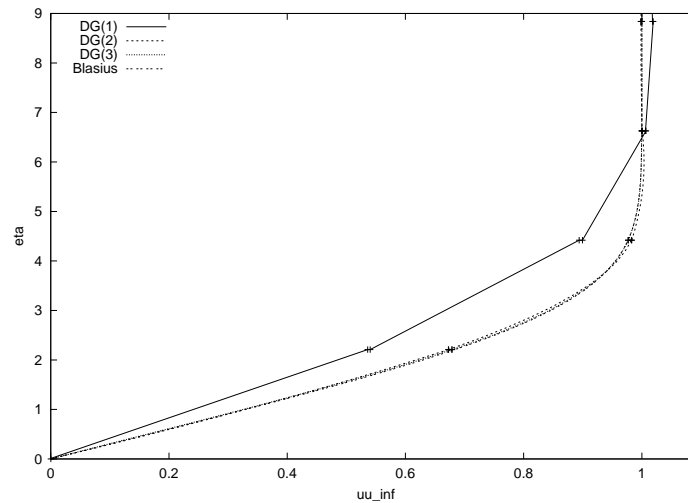
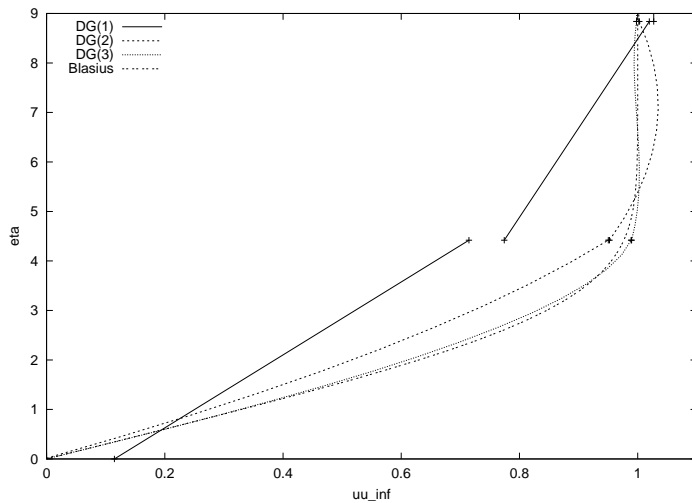

Higher order approximation of viscous boundary layers

Flat plate problem: $M = 0.01$, $Re = 10000$

Approximation of viscous force exerted on wall up to 5% requires

	DG(1)	DG(2)	DG(3)
elements	36	5	3
DoF	72	15	12

orthogonal to the wall

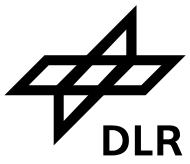

Local refinement: residual based

Local refinement: residual based

Test case: NACA0012, $M = 0.5$, $\alpha = 0$, $Re = 5000$

cdp

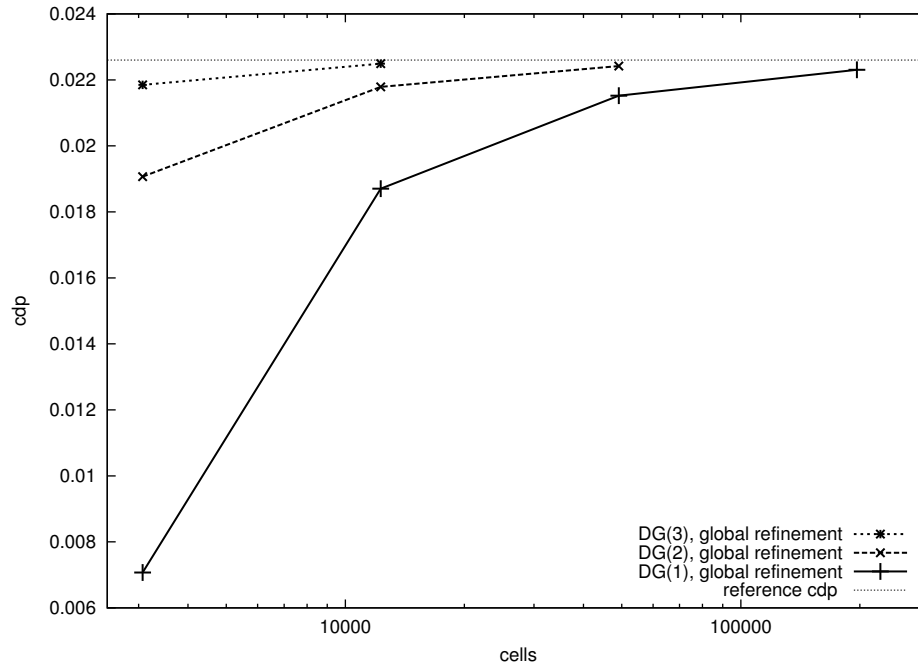

reference cdp - cdp

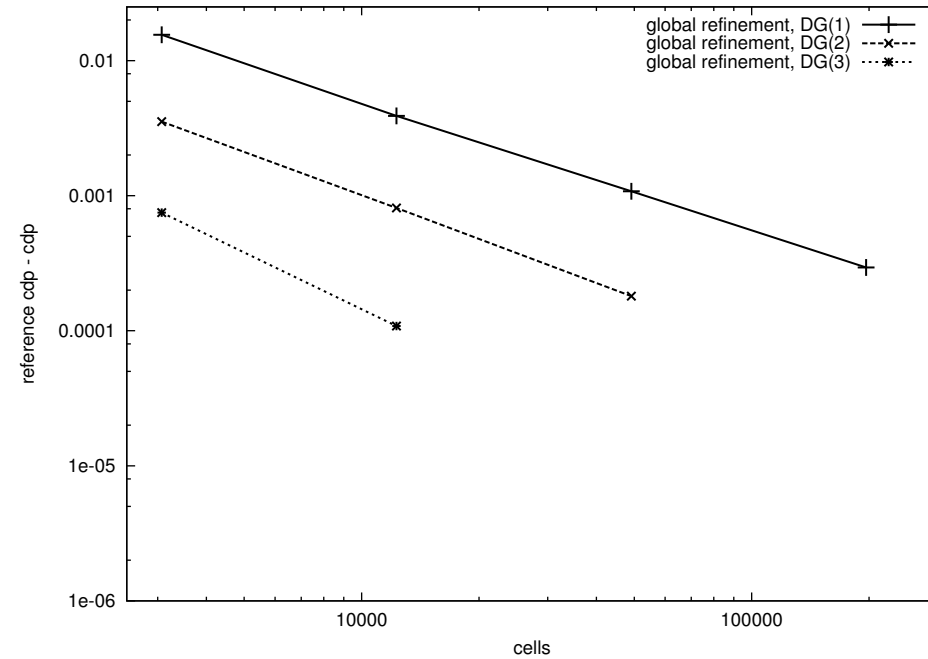

Local refinement: residual based

Test case: NACA0012, $M = 0.5$, $\alpha = 0$, $Re = 5000$

cdp

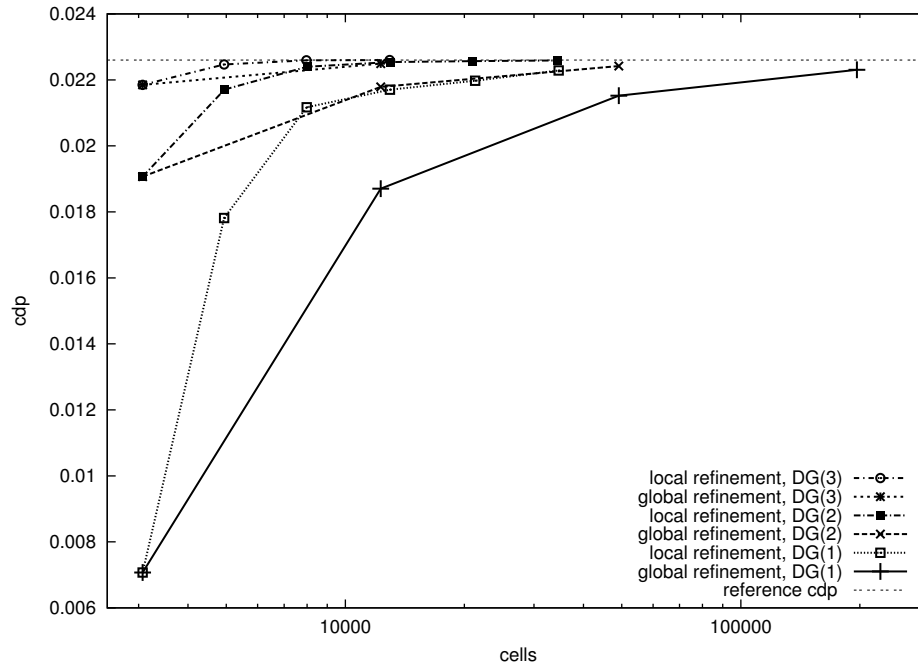

reference cdp - cdp

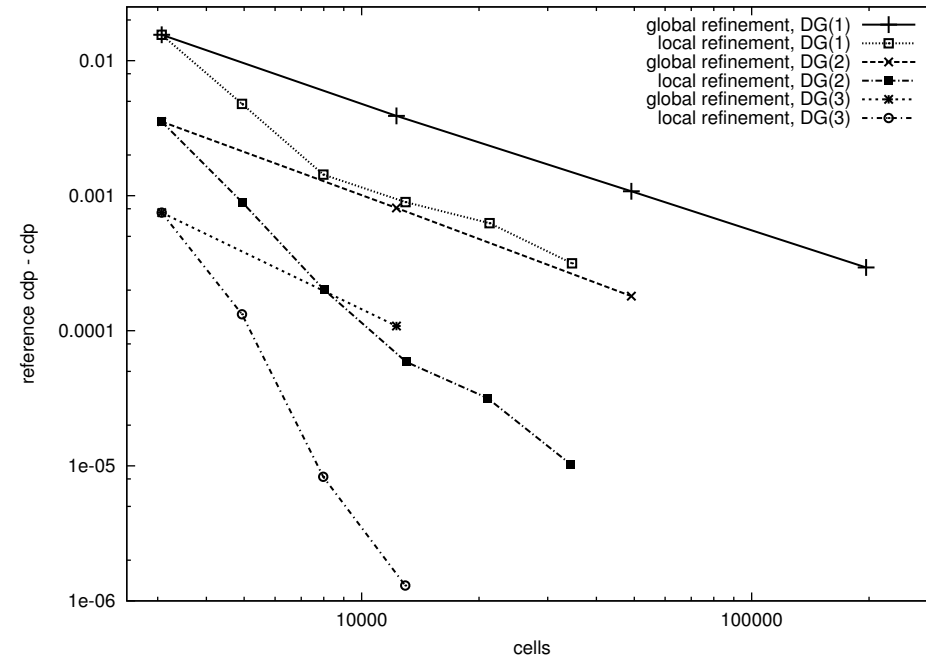

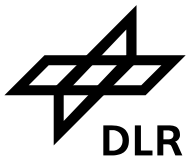

Shock-capturing

Shock-capturing (compressible Euler equations)

Add a consistent shock-capturing term

$$\int_{\kappa} \varepsilon(\mathbf{u}_h) \nabla \mathbf{u}_h : \nabla \mathbf{v}_h \, dx,$$

with $\varepsilon(\mathbf{u}_h) = ch^\alpha \tilde{\mathbf{R}}(\mathbf{u}_h) = ch^\alpha |\nabla \cdot \mathcal{F}^c(\mathbf{u}_h)|$.

Ramp problem:

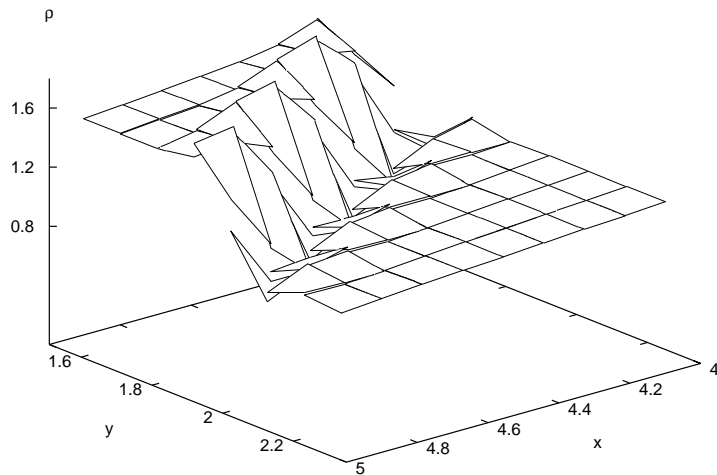

without shock-capturing

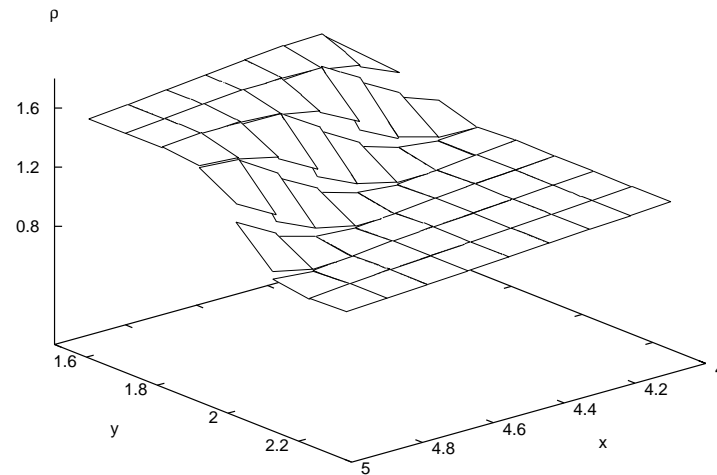

with shock-capturing

Shock-capturing (compressible Navier-Stokes equations)

$$\int_{\kappa} \varepsilon_i(\mathbf{u}_h) \partial_{x_i} \mathbf{u}_h \cdot \partial_{x_i} \mathbf{v}_h \, dx, \quad \text{with } \varepsilon_i(\mathbf{u}_h) = ch_i^\alpha \tilde{\mathbf{R}}(\mathbf{u}_h) = ch_i^\alpha |\nabla \cdot \mathcal{F}^c(\mathbf{u}_h) - \nabla \cdot \mathcal{F}^v(\mathbf{u}_h, \nabla \mathbf{u}_h)|$$

$M = 2, Re = 106, \alpha = 10^\circ$ flow around NACA0012 airfoil:

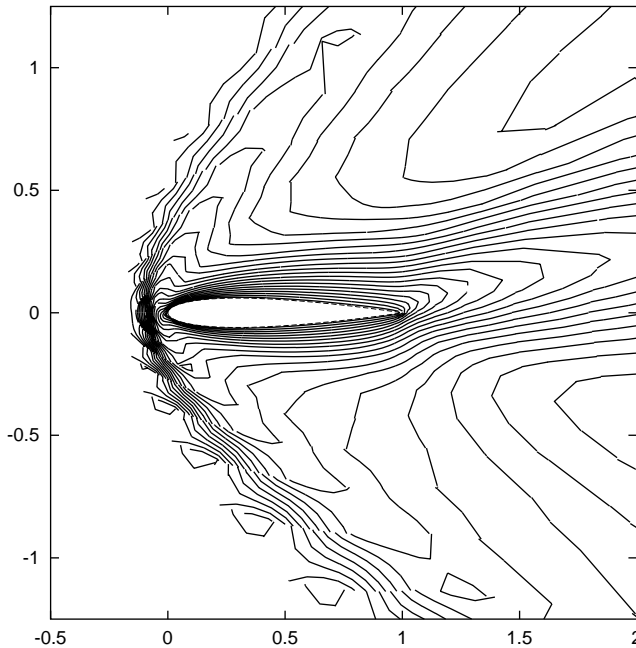

without shock-capturing

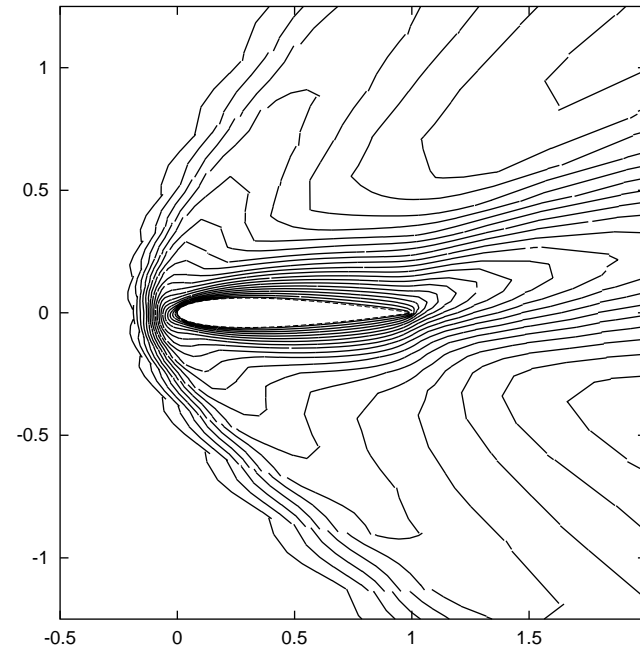

with shock-capturing

Shock-capturing (compressible Navier-Stokes equations)

$M = 2, Re = 106, \alpha = 10^\circ$ flow around NACA0012 airfoil

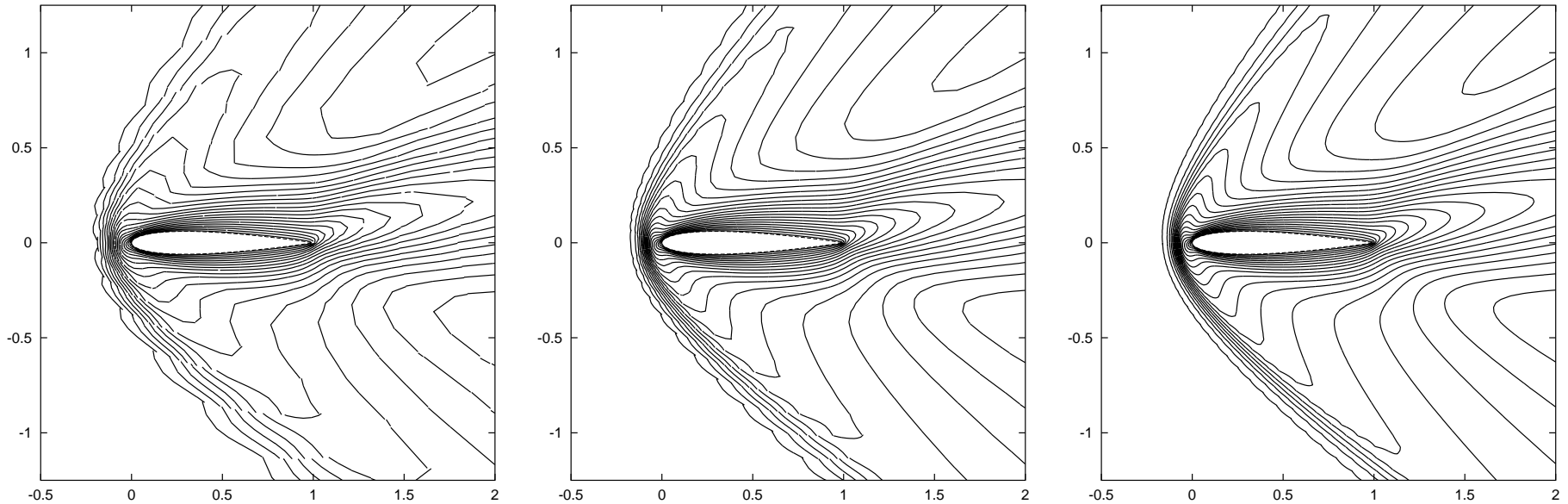

with shock-capturing on a sequence of globally refined grids

Duality-based *a posteriori* error estimation

Error representation with respect to a target quantity $J(\mathbf{u})$:

$$J(\mathbf{u}) - J(\mathbf{u}_h) = -\mathcal{N}(\mathbf{u}_h, \mathbf{z} - \mathbf{z}_h),$$

where $\mathbf{z}_h \in V_h^p$, and \mathbf{z} is the solution to the *dual or adjoint* problem: find $\mathbf{z} \in V$ such that

$$\mathcal{M}(\mathbf{u}, \mathbf{u}_h; \mathbf{w}, \mathbf{z}) = J(\mathbf{w}) \quad \forall \mathbf{w} \in V.$$

where $\mathcal{M}(\mathbf{u}, \mathbf{u}_h; \cdot, \cdot)$ denotes the mean-value linearization

$$\begin{aligned} \mathcal{M}(\mathbf{u}, \mathbf{u}_h; \mathbf{u} - \mathbf{u}_h, \mathbf{v}) &= \mathcal{N}(\mathbf{u}, \mathbf{v}) - \mathcal{N}(\mathbf{u}_h, \mathbf{v}) \\ &= \int_0^1 \mathcal{N}'[\theta \mathbf{u} + (1 - \theta) \mathbf{u}_h](\mathbf{u} - \mathbf{u}_h, \mathbf{v}) \, d\theta \end{aligned}$$

Duality-based *a posteriori* error estimation

Error representation with respect to a target quantity $J(\mathbf{u})$:

$$J(\mathbf{u}) - J(\mathbf{u}_h) = -\mathcal{N}(\mathbf{u}_h, \mathbf{z} - \mathbf{z}_h),$$

where $\mathbf{z}_h \in \mathbf{V}_h^p$, and \mathbf{z} is the solution to the *dual or adjoint* problem: find $\mathbf{z} \in \mathbf{V}$ such that

$$\mathcal{M}(\mathbf{u}, \mathbf{u}_h; \mathbf{w}, \mathbf{z}) = J(\mathbf{w}) \quad \forall \mathbf{w} \in \mathbf{V}.$$

where $\mathcal{M}(\mathbf{u}, \mathbf{u}_h; \cdot, \cdot)$ denotes the mean-value linearization

$$\begin{aligned} \mathcal{M}(\mathbf{u}, \mathbf{u}_h; \mathbf{u} - \mathbf{u}_h, \mathbf{v}) &= \mathcal{N}(\mathbf{u}, \mathbf{v}) - \mathcal{N}(\mathbf{u}_h, \mathbf{v}) \\ &= \int_0^1 \mathcal{N}'[\theta \mathbf{u} + (1 - \theta) \mathbf{u}_h](\mathbf{u} - \mathbf{u}_h, \mathbf{v}) \, d\theta \end{aligned}$$

Linearized dual problem: find $\tilde{\mathbf{z}} \in \mathbf{V}$ such that

$$\mathcal{M}(\mathbf{u}_h, \mathbf{u}_h; \mathbf{w}, \tilde{\mathbf{z}}) = \mathcal{N}'[\mathbf{u}_h](\mathbf{w}, \tilde{\mathbf{z}}) = J(\mathbf{w}) \quad \forall \mathbf{w} \in \mathbf{V}.$$

Discretized dual problem: find $\tilde{\mathbf{z}}_h \in \mathbf{V}_h^{\tilde{p}}$ such that

$$\mathcal{N}'[\mathbf{u}_h](\mathbf{w}, \tilde{\mathbf{z}}_h) = J(\mathbf{w}_h) \quad \forall \mathbf{w}_h \in \mathbf{V}_h^{\tilde{p}}.$$

$$J(\mathbf{u}) - J(\mathbf{u}_h) \approx -\mathcal{N}(\mathbf{u}_h, \tilde{\mathbf{z}}_h - \mathbf{z}_h)$$

$$J(\mathbf{u}) - J(\mathbf{u}_h) \approx \sum_{\kappa \in \mathcal{T}_h} \left\{ \int_{\kappa} R(\mathbf{u}_h) (\tilde{\mathbf{z}}_h - \mathbf{z}_h) \, d\mathbf{x} + \int_{\partial\kappa} r(\mathbf{u}_h) (\tilde{\mathbf{z}}_h - \mathbf{z}_h) \, ds \right\} =: \sum_{\kappa \in \mathcal{T}_h} \eta_{\kappa} =: \eta$$

Error estimation and goal-oriented mesh refinement

$$J(\mathbf{u}) - J(\mathbf{u}_h) \approx -\mathcal{N}(\mathbf{u}_h, \tilde{\mathbf{z}}_h - \mathbf{z}_h)$$

$$J(\mathbf{u}) - J(\mathbf{u}_h) \approx \sum_{\kappa \in \mathcal{T}_h} \left\{ \int_{\kappa} R(\mathbf{u}_h) (\tilde{\mathbf{z}}_h - \mathbf{z}_h) \, dx + \int_{\partial\kappa} r(\mathbf{u}_h) (\tilde{\mathbf{z}}_h - \mathbf{z}_h) \, ds \right\} =: \sum_{\kappa \in \mathcal{T}_h} \eta_{\kappa} =: \eta$$

$J(\mathbf{u})$ **target quantity, e.g. $J(\mathbf{u}) = c_d$, $J(\mathbf{u}) = c_l$, etc.**

$R(\mathbf{u}_h)$ **cell residuals**

$r(\mathbf{u}_h)$ **face residuals**

$\tilde{\mathbf{z}}_h \in \mathbf{V}_h^{\tilde{p}}$ **computed dual/adjoint solution**

$\mathbf{z}_h \in \mathbf{V}_h^p$ **any discrete function in \mathbf{V}_h^p , e.g. interpolate of $\tilde{\mathbf{z}}_h$, or simply $\mathbf{z}_h = 0$**

η_{κ} **dual-weighted residual indicator used for adjoint-based refinement**

$\eta = \sum_{\kappa \in \mathcal{T}_h} \eta_{\kappa}$ **estimate of the true error $J(\mathbf{u}) - J(\mathbf{u}_h)$**

Error estimation and goal-oriented mesh refinement

$$J(\mathbf{u}) - J(\mathbf{u}_h) \approx -\mathcal{N}(\mathbf{u}_h, \tilde{\mathbf{z}}_h - \mathbf{z}_h)$$

$$J(\mathbf{u}) - J(\mathbf{u}_h) \approx \sum_{\kappa \in \mathcal{T}_h} \left\{ \int_{\kappa} R(\mathbf{u}_h) (\tilde{\mathbf{z}}_h - \mathbf{z}_h) \, dx + \int_{\partial\kappa} r(\mathbf{u}_h) (\tilde{\mathbf{z}}_h - \mathbf{z}_h) \, ds \right\} =: \sum_{\kappa \in \mathcal{T}_h} \eta_{\kappa} =: \eta$$

$J(\mathbf{u})$ **target quantity, e.g. $J(\mathbf{u}) = c_d$, $J(\mathbf{u}) = c_l$, etc.**

$R(\mathbf{u}_h)$ **cell residuals**

$r(\mathbf{u}_h)$ **face residuals**

$\tilde{\mathbf{z}}_h \in \mathbf{V}_h^{\tilde{p}}$ **computed dual/adjoint solution**

$\mathbf{z}_h \in \mathbf{V}_h^p$ **any discrete function in \mathbf{V}_h^p , e.g. interpolate of $\tilde{\mathbf{z}}_h$, or simply $\mathbf{z}_h = 0$**

η_{κ} **dual-weighted residual indicator used for adjoint-based refinement**

$\eta = \sum_{\kappa \in \mathcal{T}_h} \eta_{\kappa}$ **estimate of the true error $J(\mathbf{u}) - J(\mathbf{u}_h)$**

The error estimate η can be employed to improve the computed value $J(\mathbf{u}_h)$:

$$\tilde{J}(\mathbf{u}_h) = J(\mathbf{u}_h) + \eta$$

Error estimation and goal-oriented refinement

Viscous flow at $M = 0.5$, $Re = 5000$, $\alpha = 0$ around NACA0012 airfoil

Target quantity: $J(\mathbf{u}) = c_{dp}$

# cells	$J(\mathbf{u}) - J(\mathbf{u}_h)$	$\eta = \sum_K \eta_K$	θ
3072	1.55e-02	1.06e-02	0.68
4941	4.48e-03	3.91e-03	0.87
8133	1.28e-03	1.17e-03	0.92
13521	3.33e-04	3.15e-04	0.95
21972	8.94e-05	8.75e-05	0.98
35823	3.15e-05	3.19e-05	1.01

Error estimation and goal-oriented refinement

Viscous flow at $M = 0.5$, $Re = 5000$, $\alpha = 0$ around NACA0012 airfoil

Target quantity: $J(\mathbf{u}) = c_{dp}$

# cells	$J(\mathbf{u}) - J(\mathbf{u}_h)$	$\eta = \sum_K \eta_K$	θ
3072	1.55e-02	1.06e-02	0.68
4941	4.48e-03	3.91e-03	0.87
8133	1.28e-03	1.17e-03	0.92
13521	3.33e-04	3.15e-04	0.95
21972	8.94e-05	8.75e-05	0.98
35823	3.15e-05	3.19e-05	1.01

reference cdp - cdp

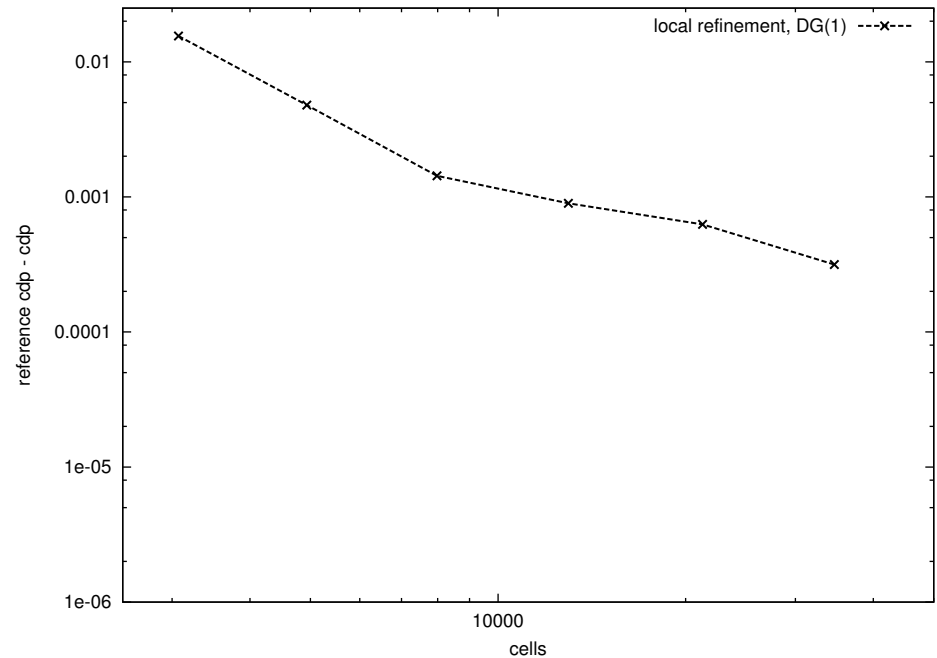

Error estimation and goal-oriented refinement

Viscous flow at $M = 0.5$, $Re = 5000$, $\alpha = 0$ around NACA0012 airfoil

Target quantity: $J(\mathbf{u}) = c_{dp}$

# cells	$J(\mathbf{u}) - J(\mathbf{u}_h)$	$\eta = \sum_K \eta_K$	θ
3072	1.55e-02	1.06e-02	0.68
4941	4.48e-03	3.91e-03	0.87
8133	1.28e-03	1.17e-03	0.92 </td
13521	3.33e-04	3.15e-04	0.95
21972	8.94e-05	8.75e-05	0.98
35823	3.15e-05	3.19e-05	1.01

reference cdp - cdp

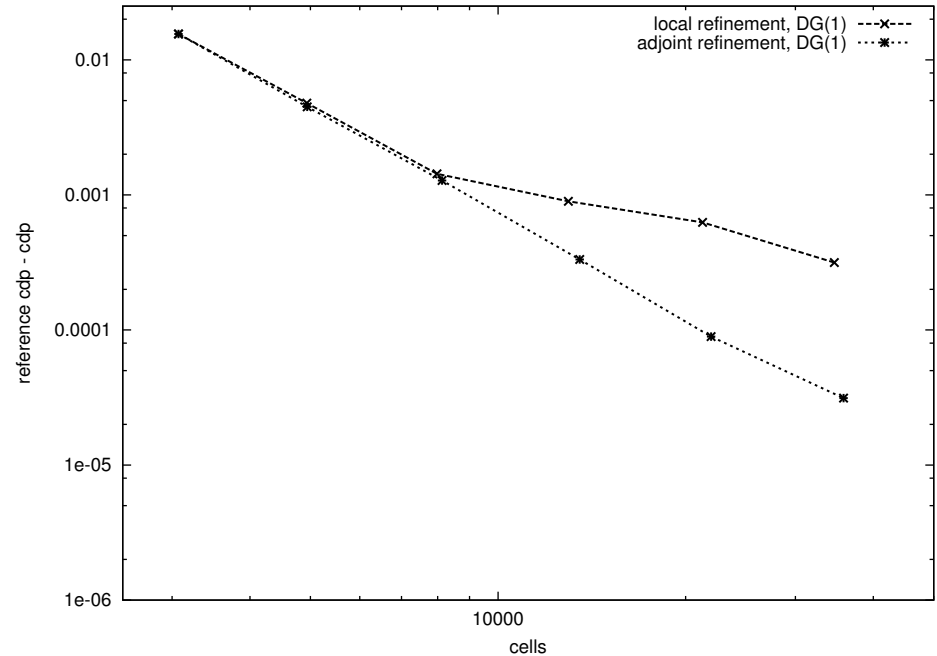

Error estimation and goal-oriented refinement

Viscous flow at $M = 0.5$, $Re = 5000$, $\alpha = 0$ around NACA0012 airfoil

Target quantity: $J(\mathbf{u}) = c_{dp}$

# cells	$J(\mathbf{u}) - J(\mathbf{u}_h)$	$\eta = \sum_K \eta_K$	θ
3072	1.55e-02	1.06e-02	0.68
4941	4.48e-03	3.91e-03	0.87
8133	1.28e-03	1.17e-03	0.92
13521	3.33e-04	3.15e-04	0.95
21972	8.94e-05	8.75e-05	0.98
35823	3.15e-05	3.19e-05	1.01

reference cdp - cdp

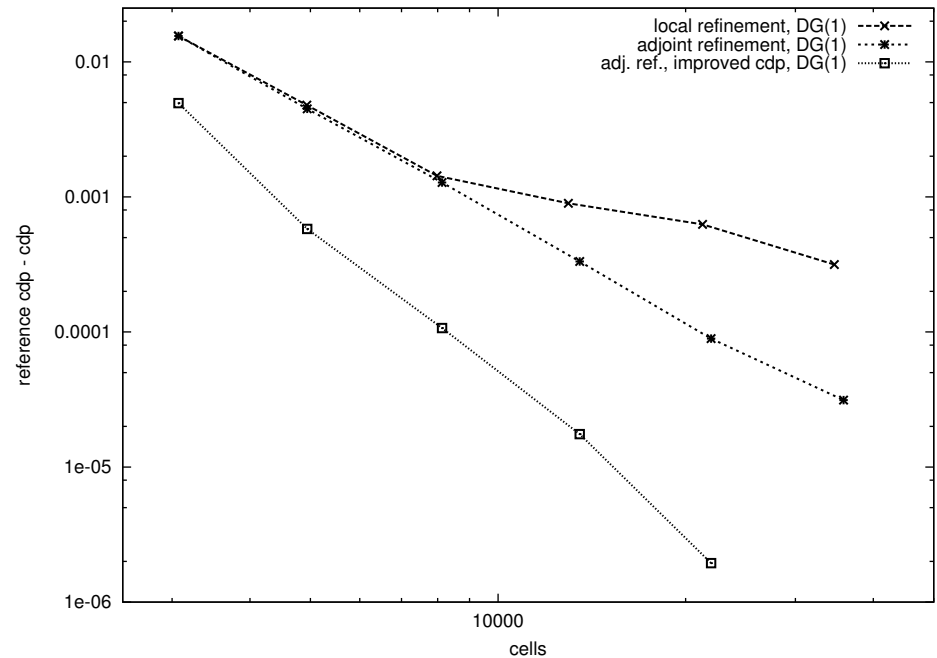

Error estimation and goal-oriented refinement

Viscous flow at $M = 0.5$, $Re = 5000$, $\alpha = 0$ around NACA0012 airfoil

Target quantity: $J(\mathbf{u}) = c_{df}$

# cells	$J(\mathbf{u}) - J(\mathbf{u}_h)$	$\eta = \sum_K \eta_K$	θ
3072	-1.856e-02	-1.282e-02	0.69
4959	-3.699e-03	-3.260e-03	0.88
8040	-8.245e-04	-7.602e-04	0.92
13473	-1.756e-04	-1.665e-04	0.95
21783	-4.337e-05	-4.148e-05	0.96
35214	-1.534e-05	-1.542e-05	1.01

cdf - reference cdf

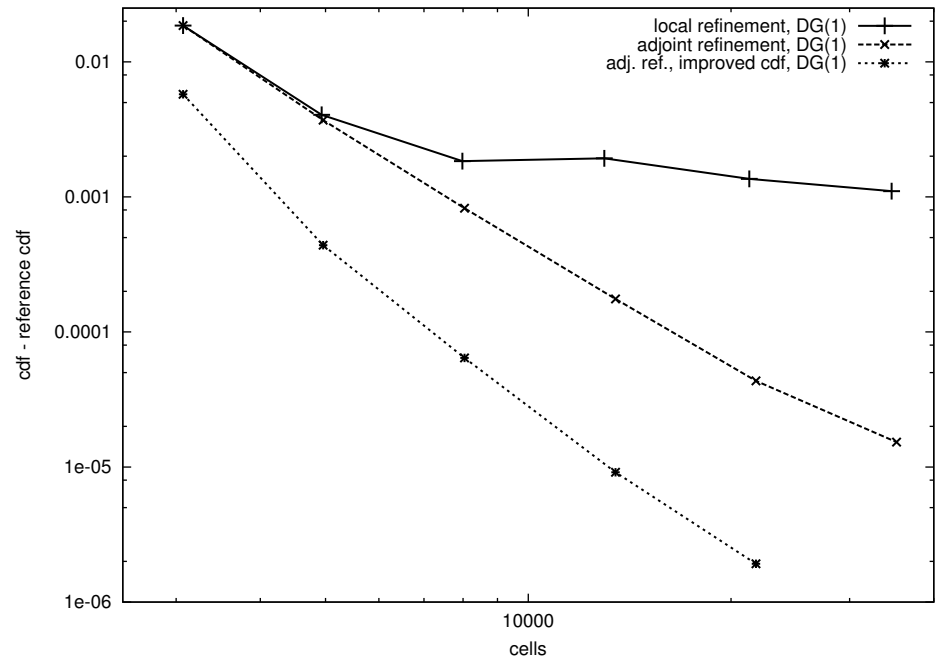

A posteriori error estimation

Viscous flow at $M = 1.2$, $Re = 1000$, $\alpha = 0$ around NACA0012 airfoil

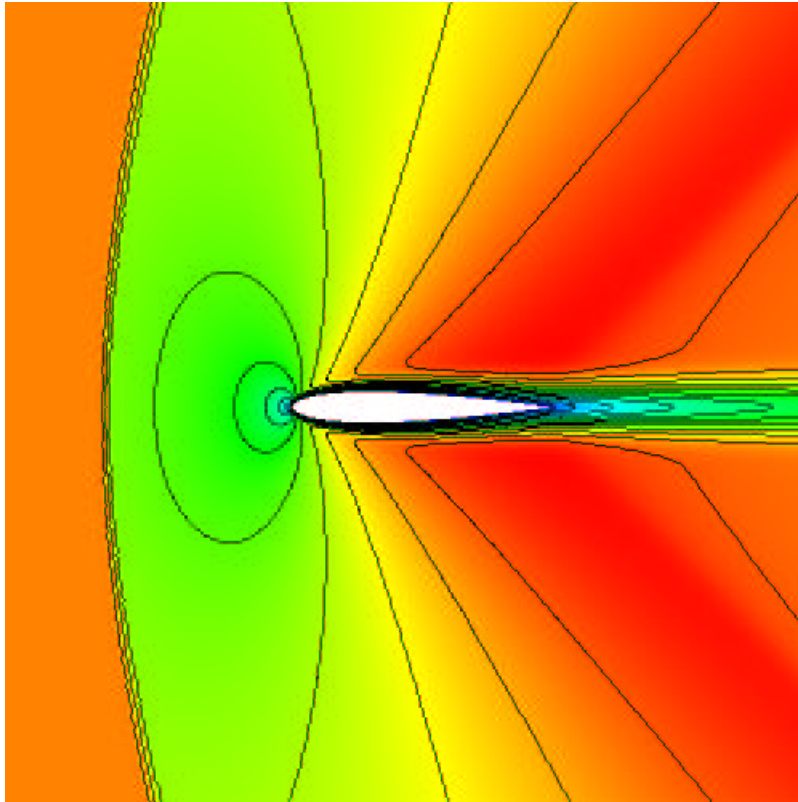

Mach isolines: close view

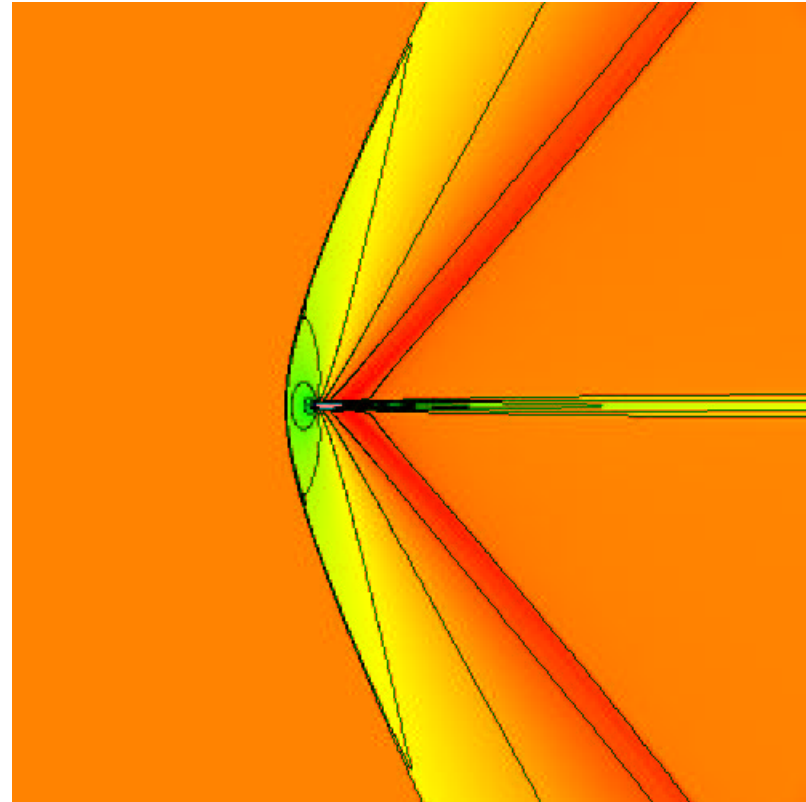

Mach isolines: distant view

A posteriori error estimation

Viscous flow at $M = 1.2$, $Re = 1000$, $\alpha = 0$ around NACA0012 airfoil

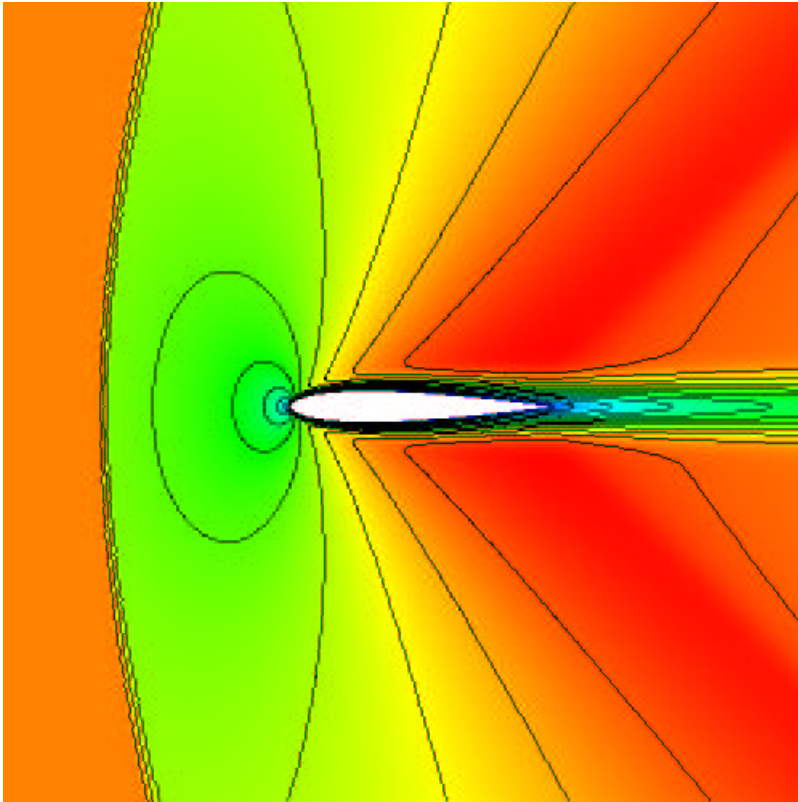

Target quantity: $J(\mathbf{u}) = c_{dp}$

# cells	$J(\mathbf{u}) - J(\mathbf{u}_h)$	$\eta = \sum_K \eta_K$	θ
768	-1.363e-02	-6.312e-03	0.46
1260	-3.203e-03	-2.995e-03	0.94
2154	-4.844e-04	-5.368e-04	1.11
3570	-3.474e-04	-3.333e-04	0.96
6021	-1.835e-04	-1.856e-04	1.01
10038	-1.644e-04	-1.653e-04	1.01

A posteriori error estimation

Viscous flow at $M = 1.2$, $Re = 1000$, $\alpha = 0$ around NACA0012 airfoil

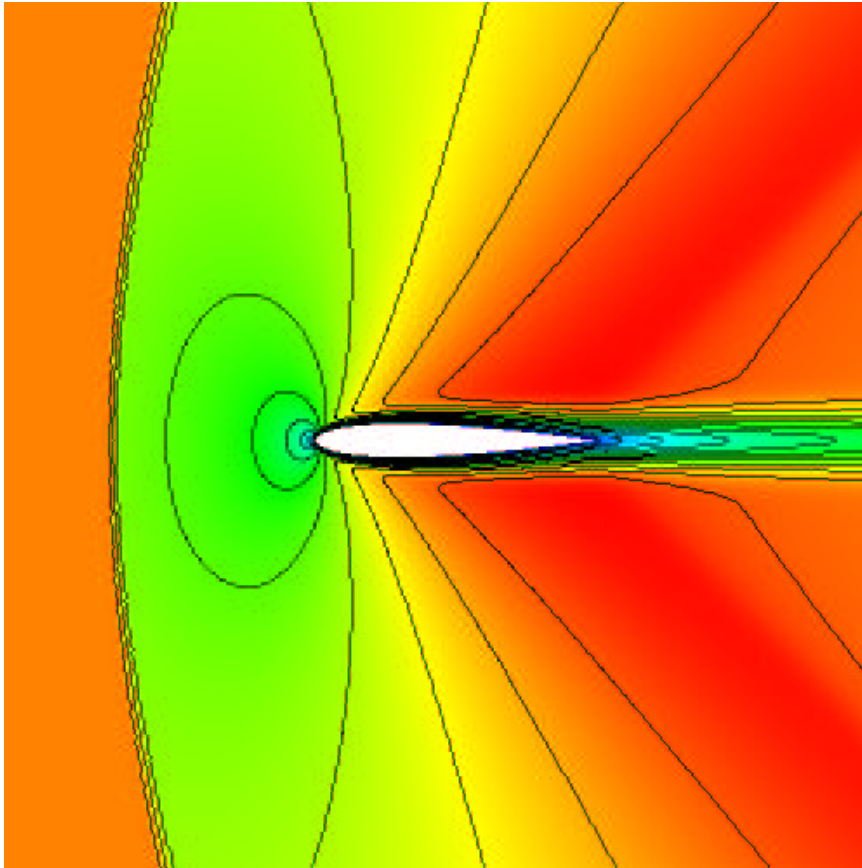

Mach isolines of primal solution

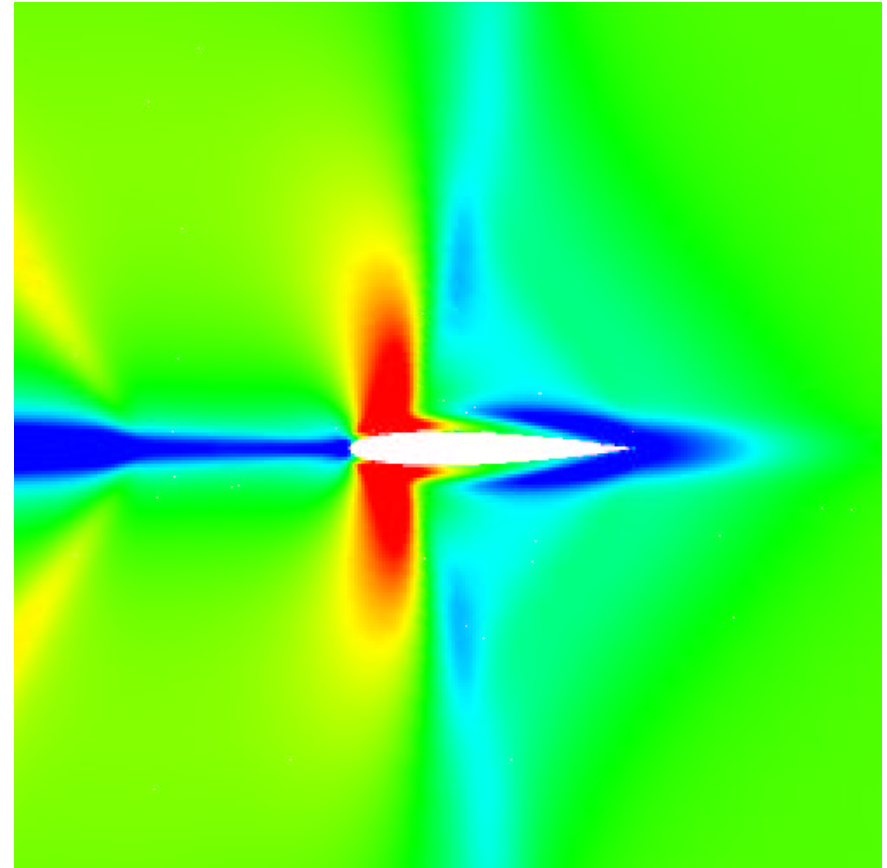

z_1 component of dual solution ($J(\mathbf{u}) = c_{dp}$)

A posteriori error estimation

Viscous flow at $M = 1.2$, $Re = 1000$, $\alpha = 0$ around NACA0012 airfoil

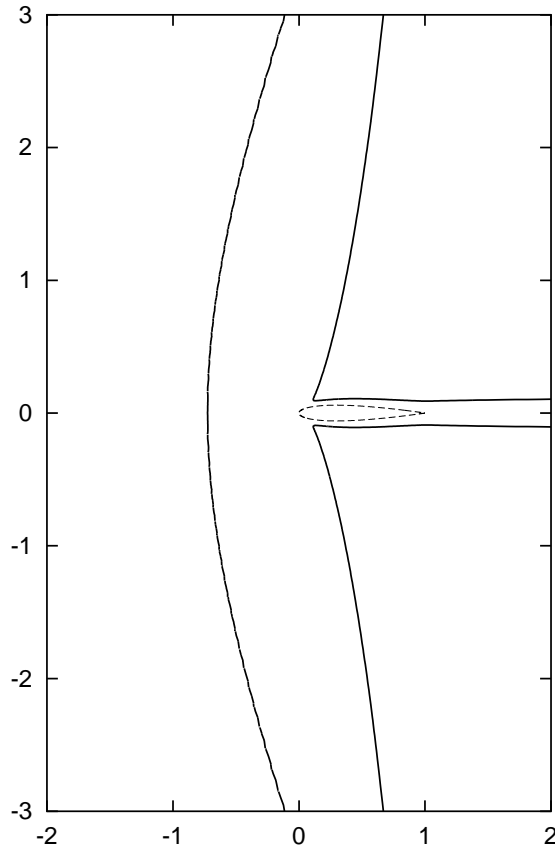

Sonic Mach isolines ($M = 1$) of
primal solution

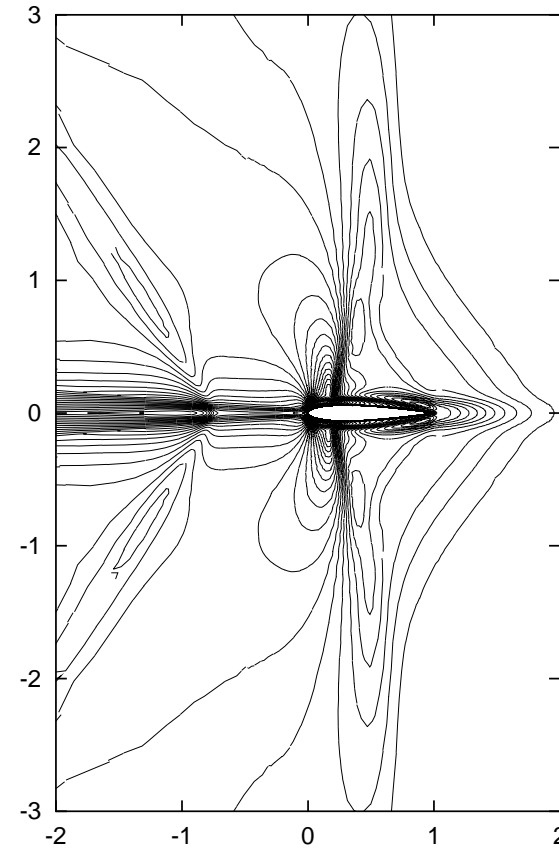

z_1 isolines of
dual solution ($J(\mathbf{u}) = c_{dp}$)

A posteriori error estimation

Viscous flow at $M = 1.2$, $Re = 1000$, $\alpha = 0$ around NACA0012 airfoil

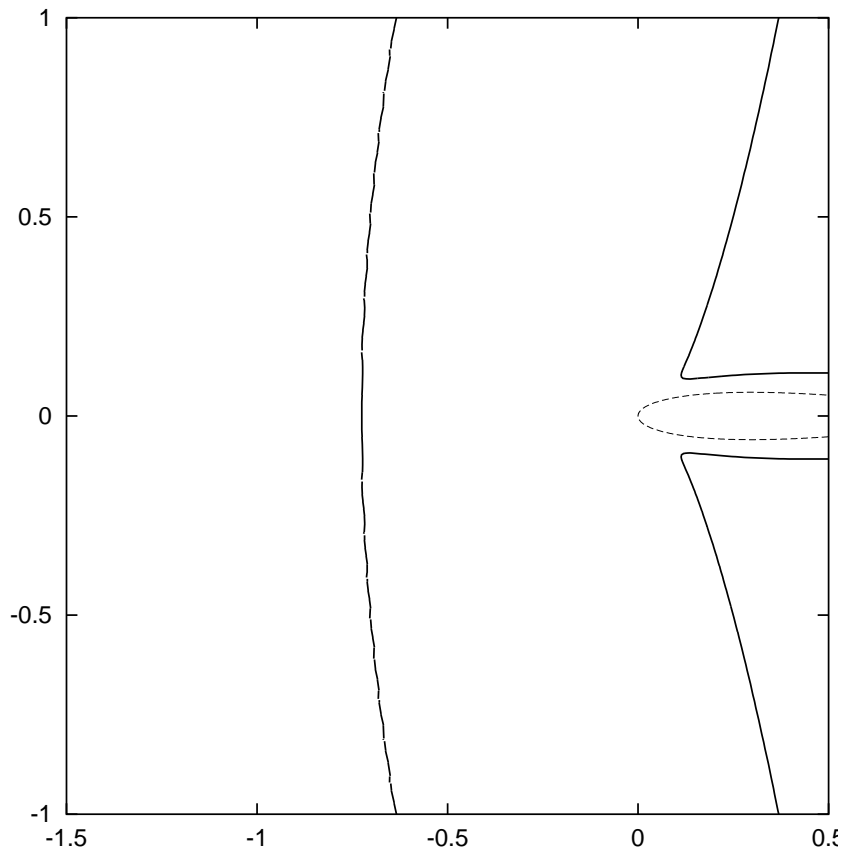

Sonic Mach isolines ($M = 1$) of primal solution

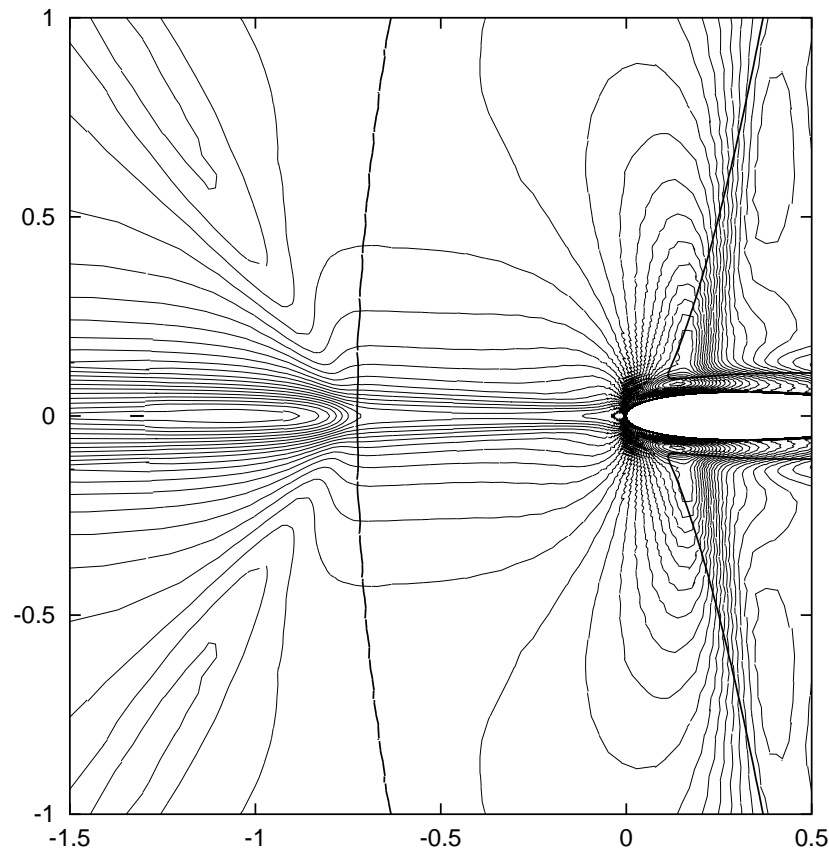

z_1 isolines of dual solution ($J(u) = c_{dp}$)

Viscous flow at $M = 1.2$, $Re = 1000$, $\alpha = 0$ around NACA0012 airfoil

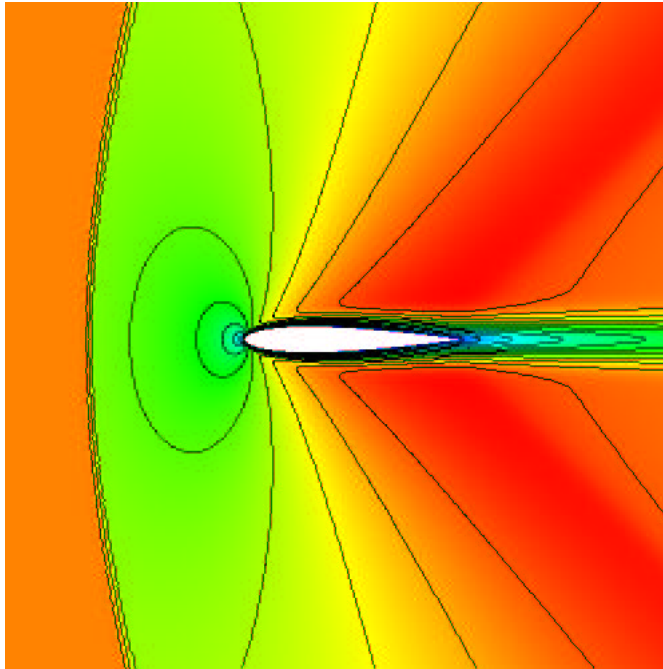

Mach isolines: close view

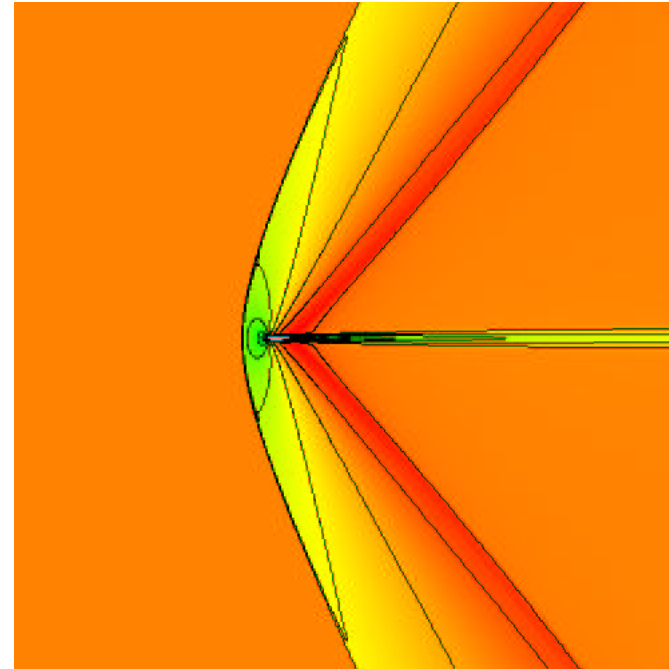

Mach isolines: distant view

Viscous flow at $M = 1.2$, $Re = 1000$, $\alpha = 0$ around NACA0012 airfoil

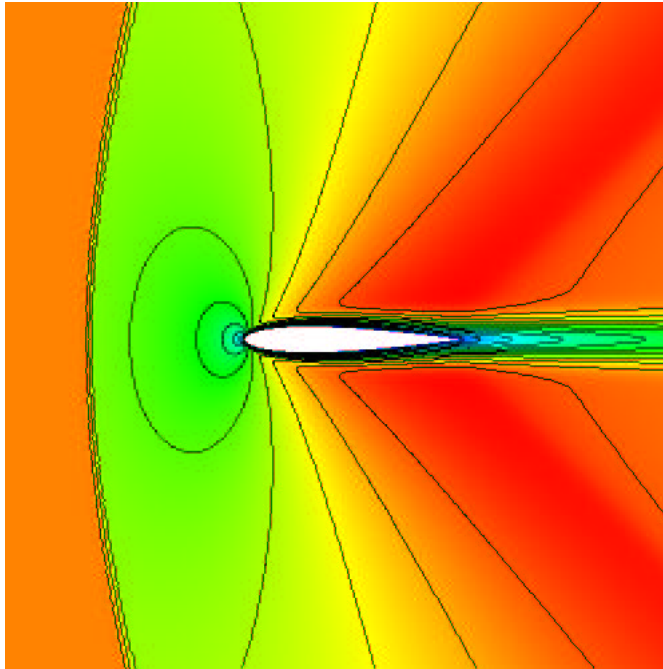

Mach isolines: close view

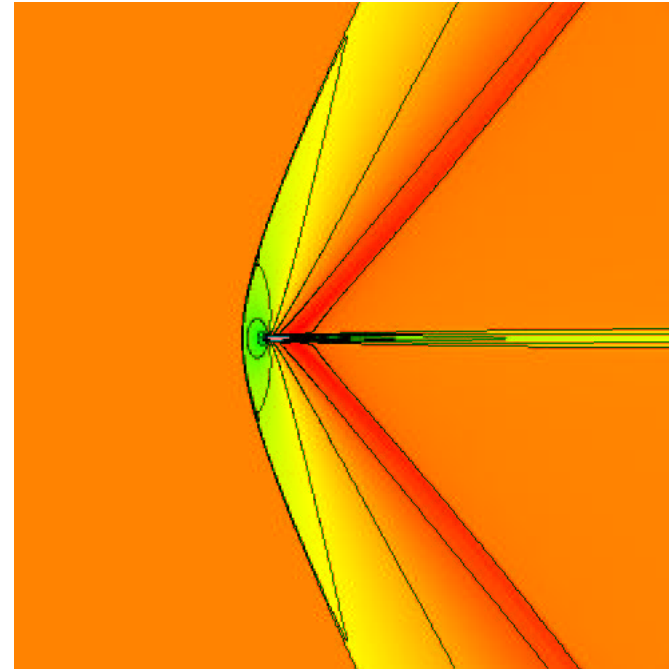

Mach isolines: distant view

For the efficient and accurate approximation of $J(\mathbf{u}) = c_{dp}$:

Viscous flow at $M = 1.2$, $Re = 1000$, $\alpha = 0$ around NACA0012 airfoil

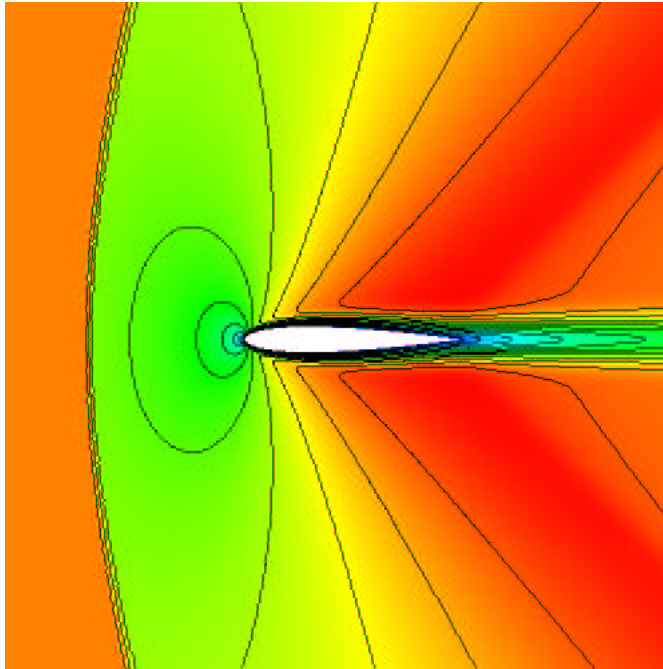

Mach isolines: close view

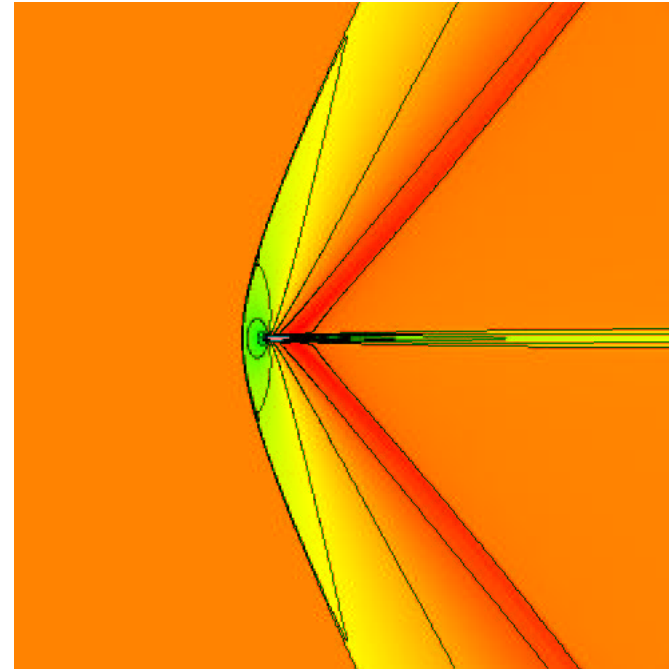

Mach isolines: distant view

For the efficient and accurate approximation of $J(\mathbf{u}) = c_{dp}$:

How should the mesh look like?

Goal-oriented refinement ($M = 1.2, Re = 1000, \alpha = 0, \text{NACA0012}$)

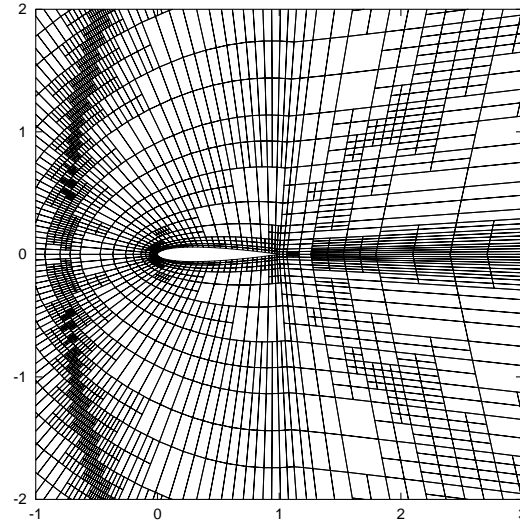
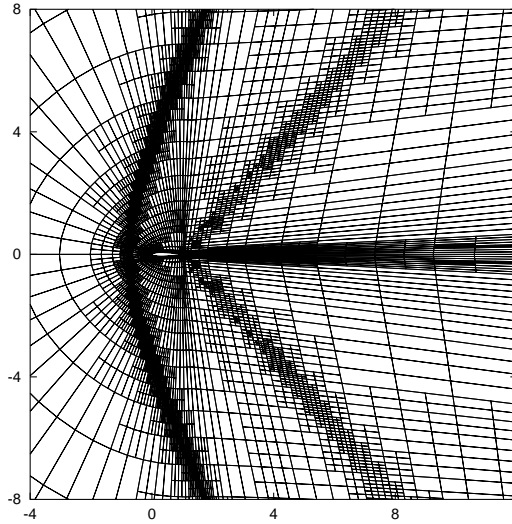

Goal-oriented refinement ($M = 1.2, Re = 1000, \alpha = 0, \text{NACA0012}$)

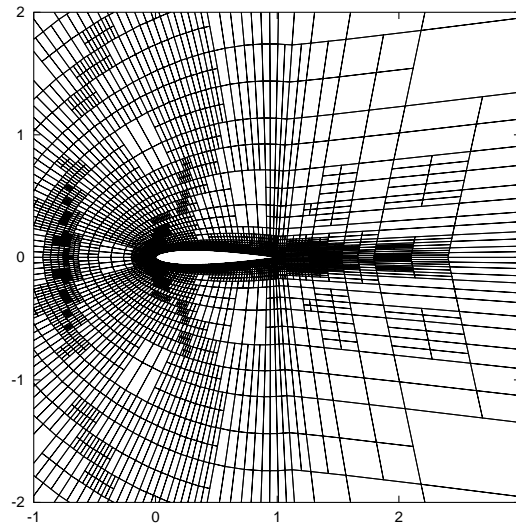
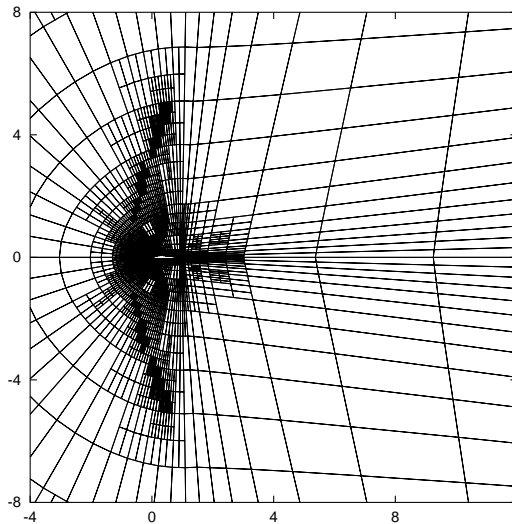
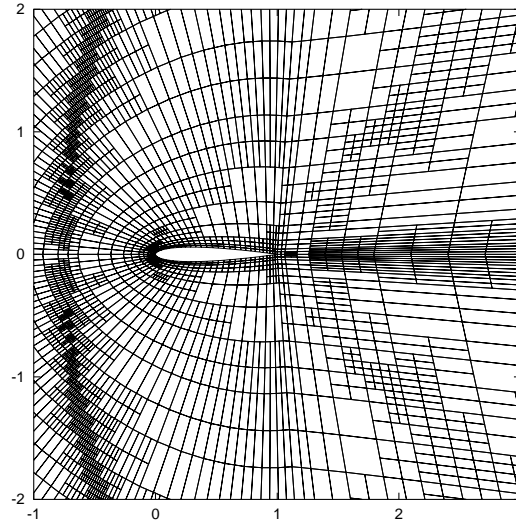
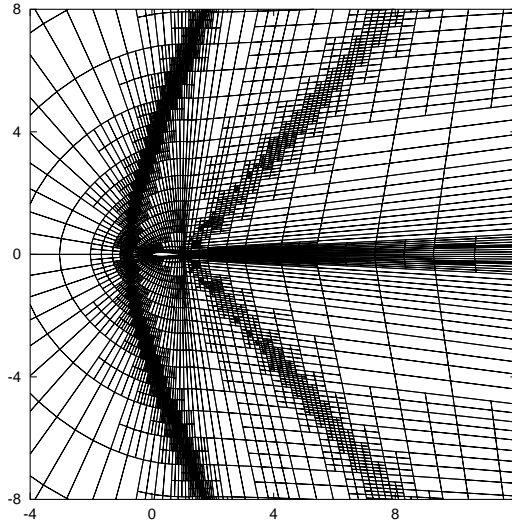

Goal-oriented refinement ($M = 1.2, Re = 1000, \alpha = 0, \text{NACA0012}$)

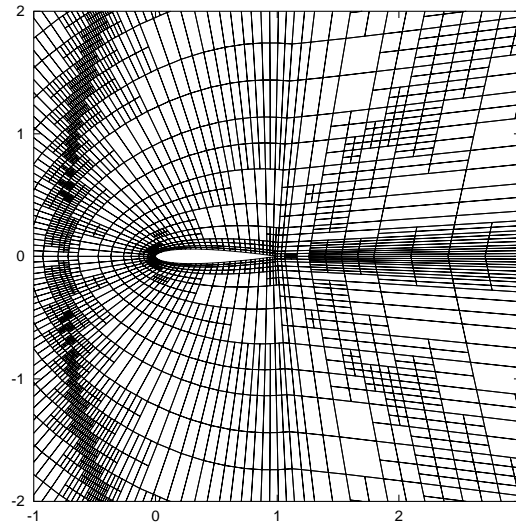
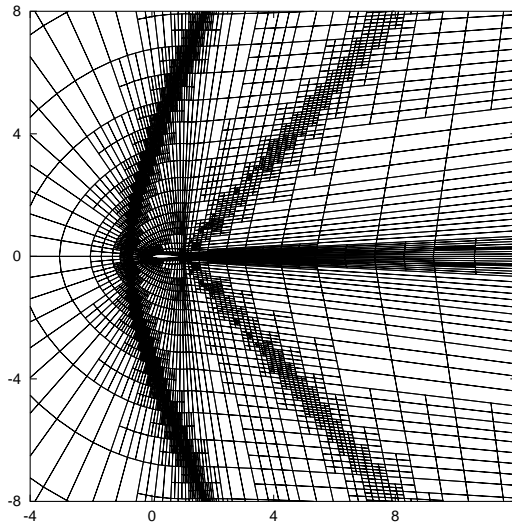

Residual-based refinement:
17670 cells with 282720 dofs
 error in c_{dp} : $1.9 \cdot 10^{-3}$
 error in c_{df} : $1.1 \cdot 10^{-2}$

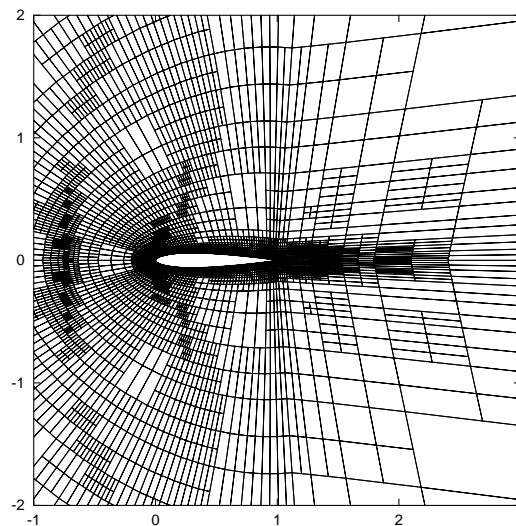
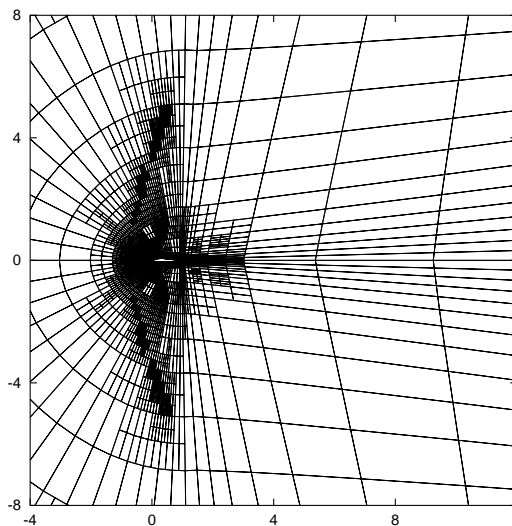

Goal-oriented refinement ($M = 1.2, Re = 1000, \alpha = 0, \text{NACA0012}$)

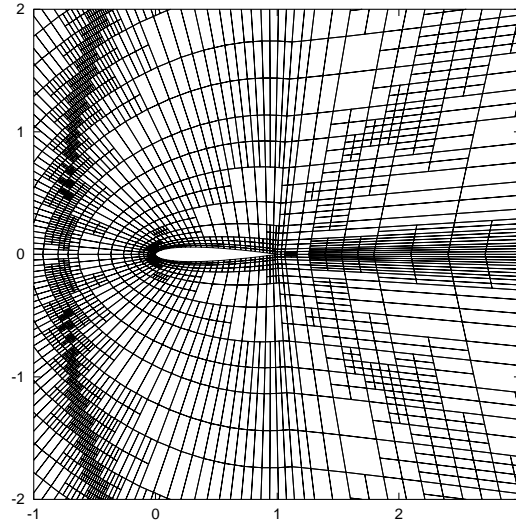
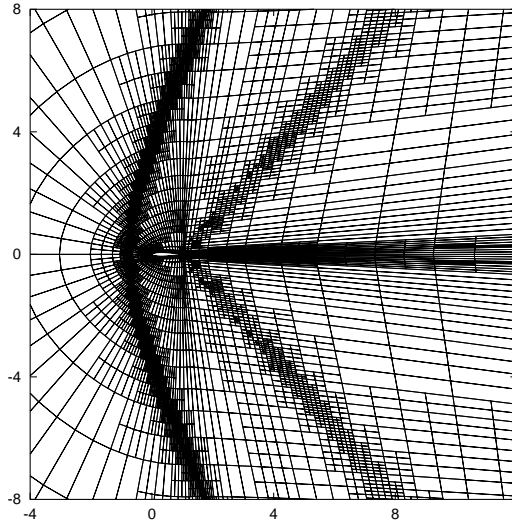

Residual-based refinement:
17670 cells with 282720 dofs
 error in c_{dp} : $1.9 \cdot 10^{-3}$
 error in c_{df} : $1.1 \cdot 10^{-2}$

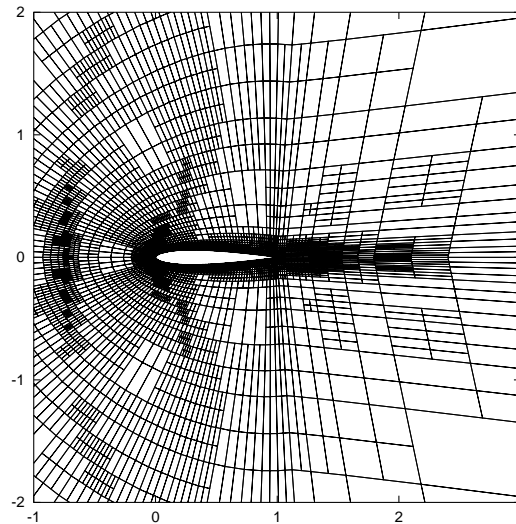
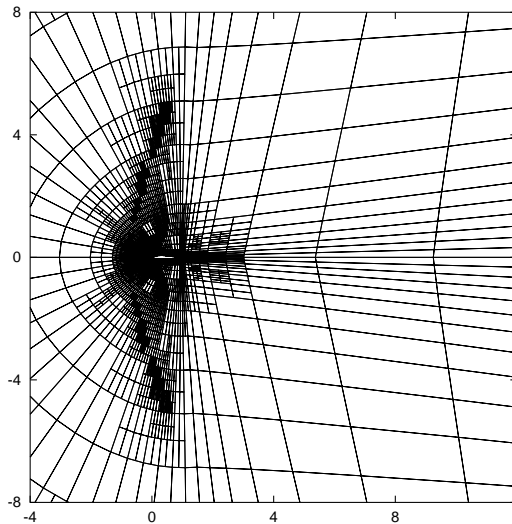

Goal-oriented refinement:
10038 cells with 160608 dofs
 error in c_{dp} : $1.6 \cdot 10^{-4}$
 error in c_{df} : $7.2 \cdot 10^{-4}$

- ▶ **Extension of the DG flow solver to 3d turbulent, high Reynolds flow**
- ▶ **These extensions also for**
 - **the computation of the dual (adjoint) solution**
 - **the evaluation of refinement indicators (residual-based and adjoint-based)**
 - **and the error estimation in terms of e.g. drag and lift coefficients**
- ▶ **Extension of single target quantity to multiple target quantities**
- ▶ **Error estimation of discretization and model errors**
- ▶ **Extension of isotropic to anisotropic refinement**
- ▶ **Extension to hp refinement**
- ▶ **Efficient solution techniques:**
 - **linear and nonlinear multigrid**
 - **h- and p-multigrid**